

DIPLOMADO DE PROFUNDIZACION CISCO CCNP SOLUCIÓN DE DOS
ESCENARIOS PRESENTES EN ENTORNOS CORPORATIVOS BAJO EL USO
DE TECNOLOGÍA CISCO

JOSE NICOLAS HERNANDEZ LOPEZ

UNIVERSIDAD NACIONAL ABIERTA Y A DISTANCIA - UNAD
ESCUELA DE CIENCIAS BÁSICAS, TECNOLOGÍA E INGENIERÍA - ECBTI
INGENIERÍA ELECTRONICA
BARRANQUILLA
2020

DIPLOMADO DE PROFUNDIZACION CISCO CCNP SOLUCIÓN DE DOS
ESCENARIOS PRESENTES EN ENTORNOS CORPORATIVOS BAJO EL USO
DE TECNOLOGÍA CISCO

JOSE NICOLAS HERNANDEZ LOPEZ

Diplomado de opción de grado presentado para optar el
título de INGENIERO ELECTRONICO

DIRECTOR:
MSc. GERARDO GRANADOS ACUÑA

UNIVERSIDAD NACIONAL ABIERTA Y A DISTANCIA - UNAD
ESCUELA DE CIENCIAS BÁSICAS, TECNOLOGÍA E INGENIERÍA - ECBTI
INGENIERÍA ELECTRONICA
BARRANQUILLA
2020

NOTA DE ACEPTACIÓN

Firma del Presidente del Jurado

Firma del Jurado

Firma del Jurado

Barranquilla, 30 de noviembre de 2020

AGRADECIMIENTOS

Primeramente, a Dios por la oportunidad y la fuerza que me ha dado para alcanzar este logro. A mi esposa Angela y mis hijas Amanda y Angie por el apoyo incondicional que me brindaron durante las etapas más difíciles de la carrera, A todas aquellas personas que con su amistad me demostraron lo importante que es confiar en nuestras capacidades y a las personas que conforman la administración, grupo de directores, docentes y tutores que hicieron parte del proceso de formación a través de la Universidad Nacional Abierta y a Distancia – UNAD.

¡Gracias!

CONTENIDO

AGRADECIMIENTOS	4
LISTA DE TABLAS	6
LISTA DE FIGURAS	7
GLOSARIO.....	8
RESUMEN.....	10
ABSTRACT	10
INTRODUCCIÓN	11
DESARROLLO	12
Escenario 1	12
Escenario 2	23
CONCLUSIONES.....	45
BIBLIOGRAFIA.....	46

LISTA DE TABLAS

Tabla 1. Direcciones de los Routers	13
Tabla 2. Configuraciones para Loopback en Router R1	18
Tabla 3. Configuraciones de Loopback en Router R5	19
Tabla 4 VLAN para los servidores	33
Tabla 5 Interfaces puertos de acceso	40

LISTA DE FIGURAS

Figura 1. Escenario 1	12
Figura 2. Conexión de Reuters en GNS3	12
Figura 3. Configuración Router 1	14
Figura 4. Configuración Router 2	15
Figura 5. Configuración Router 3	16
Figura 6. Configuración Router 4	17
Figura 7. Configuración Router 5	18
Figura 8. Configuración Loopback y OSPF en Router R1	19
Figura 9. Configuración Loopback y EIGRP 15 en Router R5	20
Figura 10. Route R3 aprendiendo las nuevas interfaces Loopback	20
Figura 11. Configuración en Router R3 - EIGRP en OSPF	21
Figura 12. Verificación en Router R1	21
Figura 13. Verificación en Router R5	22
Figura 14 Configuración inicial switch	24
Figura 15 Configuración EtherChannel capa-3	26
Figura 16 Configuración LACP	27
Figura 17 Configuración interfaces F0/9 y fa0/10 con PAgP	28
Figura 18 Configuración Vlan 500 Nativa	29
Figura 19 Configuración nombre de dominio y contraseña	31
Figura 20 Configuración DLS1 como servidor principal	31
Figura 21 Configuración clientes VTP	32
Figura 22 Configuración de las VLAN	34
Figura 23 Suspensión de la VLAN 434	35
Figura 24 Configuración VTP transparente y VLAN en DLS2	36
Figura 25 Configuración VLAN primarias y secundarias en DLS1	38
Figura 26 Configuración interfaces en DLS2	41
Figura 27 Verificaciones de la existencia de las VLAN	42
Figura 28 Verificación conexión entre DLS1 y ALS1 por EtherChannel	44
Figura 29 Verificación configuración Spanning tree entre DLS1 y DLS2	44

GLOSARIO

Ethernet Channel: Es una tecnología de Cisco construida de acuerdo con los estándares 802.3 full-duplex Fast Ethernet. Permite la agrupación lógica de varios enlaces físicos Ethernet, esta agrupación es tratada como un único enlace y permite sumar la velocidad nominal de cada puerto físico Ethernet usado y así obtener un enlace troncal de alta velocidad.

LACP: Es el protocolo abierto para crear Ethernet Channels con número IEEE 802.3ad. LACP puede unir de 2 hasta 16 interfaces del mismo tipo pero solo se pueden usar 8. Los otros 8 quedan en modo pasivo o standby. No se pueden mezclar interfaces de diferentes velocidades.

PAgP: Es el protocolo propietario de CISCO para crear Ethernet Channels. PAgP puede unir hasta 8 interfaces del mismo tipo. No se pueden mezclar interfaces de diferentes velocidades. PAgP envía mensajes de control cada 30 segundos

Protocolo EIGRP: es utilizado en redes TCP/IP y de Interconexión de Sistemas Abierto (OSI) como un protocolo de enrutamiento del tipo vector distancia avanzado, propiedad de Cisco, que ofrece las mejores características de los algoritmos vector distancia y de estado de enlace.

Protocolo Open Shortest Path First (OSPF): es un protocolo de direccionamiento de tipo enlace-estado, desarrollado para las redes IP y basado en el algoritmo de primera vía más corta (SPF). OSPF es un protocolo de pasarela interior (IGP). En una red OSPF, los direccionadores o sistemas de la misma área mantienen una base de datos de enlace-estado idéntica que describe la topología del área. Cada direccionador o sistema del área genera su propia base de datos de enlace-estado a partir de los anuncios de enlace-estado (LSA) que recibe de los demás direccionadores o sistemas de la misma área y de los LSA que él mismo genera. El LSA es un paquete que contiene información sobre los vecinos y los costes de cada vía. Basándose en la base de datos de enlace-estado, cada direccionador o sistema calcula un árbol de extensión de vía más corta, siendo él mismo la raíz, utilizando el algoritmo SPF.

Router: es un dispositivo de hardware que permite la interconexión de ordenadores en red. El router o enrutador es un dispositivo que opera en capa tres de nivel de 3. Así, permite que varias redes u ordenadores se conecten entre sí y, por ejemplo, compartan una misma conexión de Internet.

Un router se vale de un protocolo de enrutamiento, que le permite comunicarse con otros enrutadores o encaminadores y compartir información entre sí para saber cuál es la ruta más rápida y adecuada para enviar datos.

Switch: dispositivo que permite que la conexión de computadoras y periféricos a la red para que puedan comunicarse entre sí y con otras redes. Se utilizan para

conectar varios dispositivos a través de la misma red. De esta manera, un switch puede conectar varias computadoras, impresoras y servidores para crear una red de servicios compartidos dentro de una oficina o edificio. Actúa como un controlador que permite que diferentes dispositivos compartan información entre sí.

VLAN: es un método que permite crear redes que lógicamente son independientes, aunque estas se encuentren dentro de una misma red física. De esta forma, un usuario podría disponer de varias VLANs dentro de un mismo router o switch. Podría decirse que cada una de estas redes agrupa los equipos de un determinado segmento de red. Crear estas particiones tiene unas ventajas bastante claras a la hora de administrar una red.

VTP (VLAN Trunking Protocol): es un protocolo de mensajes de nivel 2 usado para configurar y administrar VLANs en equipos Cisco. Permite centralizar y simplificar la administración en un dominio de VLANs, pudiendo crear, borrar y renombrar las mismas, reduciendo así la necesidad de configurar la misma VLAN en todos los nodos. El protocolo VTP nace como una herramienta de administración para redes de cierto tamaño, donde la gestión manual se vuelve inabordable.

RESUMEN

En el contenido del presente documento se encuentran desarrollados dos ejercicios denominados Escenario 1 y Escenario 2, en cada uno de ellos se encuentran aplicados los conocimientos adquiridos en las secciones del módulo de diplomado para opción de grado de la Universidad Nacional Abierta y a Distancia denominado "DIPLOMADO DE PROFUNDIZACIÓN CISCO".

En el primer escenario se muestran los aplicativos correspondientes a los protocolos OSPF y EIGRP en los dispositivos CISCO, presentando así los niveles de seguridad y las configuraciones necesarias para la protección de la red y su correcto funcionamiento.

En el escenario 2, se configura una red que contiene las tecnologías PAgP y LACP de CISCO, a través de los protocolos Etherchannel y por medio de una serie de configuraciones de VLAN.

Palabras clave: CISCO, CCNP, Conmutación, Enrutamiento, Redes, Electrónica

ABSTRACT

In the content of this document, two exercises called Scenario 1 and Scenario 2 are developed, in each of them the knowledge acquired in the sections of the diploma module for the degree option of the National Open and Distance University called "DIPLOMADO DEEPENING CISCO".

In the first scenario, the applications corresponding to the OSPF and EIGRP protocols in the CISCO devices are shown, thus presenting the security levels and the necessary configurations for the protection of the network and its correct operation.

In Scenario 2, a network is configured that contains CISCO's PAgP and LACP technologies, through Etherchannel protocols and through a series of VLAN configurations.

Keywords: CISCO, CCNP, Switching, Routing, Networks, Electronics

INTRODUCCIÓN

Por medio de los conocimientos adquiridos en el proceso de aprendizaje del modulo del diplomado CISCO, se logra desarrollar los ejercicios propuestos por parte del tutor y de la misma forma afianzar otros que son también importantes al momento de llevar todos estos conocimientos a la práctica. El diplomado cuenta con tres partes: una teórica una practica y las evaluaciones de conocimiento, esto permite que se tenga un proceso de aprendizaje detallado, además sus simulaciones son muy similares a las reales, por lo que resulta adecuado para la futura vida laboral.

El contenido documentado del informe se muestra las configuraciones necesarias para permitir el correcto enrutamiento a través de los protocolos de CISCO como lo son EIGRP y OSPF que son también conocidos como de enrutamiento interno.

Por otra parte, se evidencia como a través de los canales como Etherchannel y protocolos de CISCO como LACP y PAgP, se logra intercomunicar diversos dispositivos y que estos puedan intercambiar información de manera efectiva, así mismo, distribuir de manera correcta los servidores y clientes y la respectiva configuración de las VLAN.

DESARROLLO

Escenario 1

Teniendo en cuenta la siguiente imagen:

Figura 1. Escenario 1



Figura 2. Conexión de Routers en GNS3



1. Aplique las configuraciones iniciales y los protocolos de enrutamiento para los routers R1, R2, R3, R4 y R5 según el diagrama. No asigne passwords en los routers. Configurar las interfaces con las direcciones que se muestran en la topología de red.

Tabla 1. Direcciones de los Routers

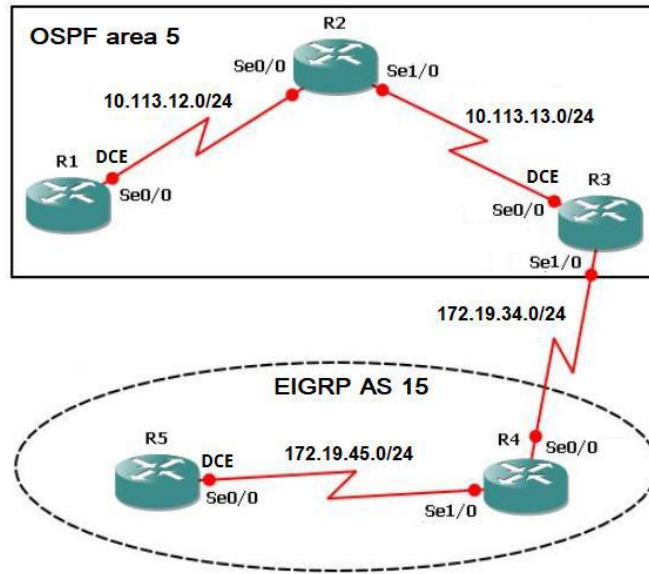
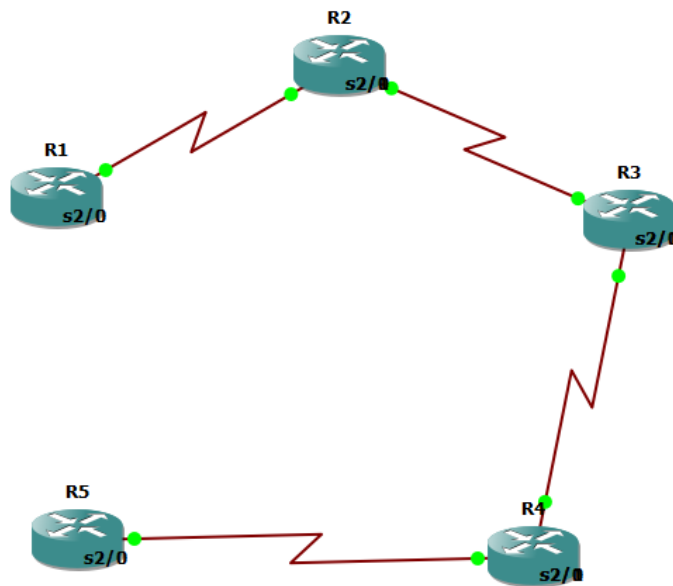
Device	Interface	IP Address	Subnet Mask
R1	S2/0	10.113.12.1	255.255.255.0
R2	S2/0	10.113.12.2	255.255.255.0
	S2/1	10.113.13.1	255.255.255.0
R3	S2/0	10.113.13.2	255.255.255.224
	S2/1	172.19.34.1	255.255.255.0
R4	S2/0	172.19.34.2	255.255.255.0
	S2/1	172.19.45.1	255.255.255.0
R5	S2/0	172.19.45.2	255.255.255.0

```

R1#enable
R1#config terminal
R1(config)#hostname R1
R1(config)# no ip domain-lookup
R1(config)# line con 0
R1(config-line)# logging synchronous
R1(config-line)# exec-timeout 0 0
R1(config-line)# exit
R1(config)#interface s2/0
R1(config-if)#bandwidth 128000
R1(config-if)#ip address 10.113.12.1 255.255.255.0
R1(config-if)#no shutdown
R1(config-if) #exit
R1(config)#router ospf 1
R1(config-router)#router-id 1.1.1.1
R1(config-router)#network 10.113.12.0 0.0.0.255 area 5
R1#show ip route
R1#copy running-config startup-config

```

Figura 3. Configuración Router 1

```
R1#
R1#ena
R1#conf t
Enter configuration commands, one per line. End with CNTL/Z.
R1(config)#hostname R1
R1(config)#no ip domain-lookup
R1(config)#line con 0
R1(config-line)#logging synchronous
R1(config-line)#exec-timeout 0 0
R1(config-line)#exit
R1(config)#interface s0/0
^
% Invalid input detected at '^' marker.

R1(config)#interface s2/0
R1(config-if)#bandwidth 128000
R1(config-if)#ip address 10.113.12.1 255.255.255.0
R1(config-if)#no shut
R1(config-if)#
*Oct 17 10:57:37.099: %LINK-3-UPDOWN: Interface Serial2/0, changed state to up
R1(config-if)#
*Oct 17 10:57:38.107: %LINEPROTO-5-UPDOWN: Line protocol on Interface Serial2/0, changed state to up
R1(config-if)#exit
R1(config)#
*Oct 17 10:58:03.499: %LINEPROTO-5-UPDOWN: Line protocol on Interface Serial2/0, changed state to down
R1(config)#
R1(config)#
R1(config)#
R1(config)#router ospf 1
R1(config-router)#router-id 1.1.1.1
R1(config-router)#network 10.113.12.0 0.0.0.255 area 5
R1(config-router)#show ip route
^
% Invalid input detected at '^' marker.

R1(config-router)#^Z
R1#show ip route
*Oct 17 11:09:02.515: %SYS-5-CONFIG_I: Configured from console by console
R1#show ip route
Codes: L - local, C - connected, S - static, R - RIP, M - mobile, B - BGP
D - EIGRP, EX - EIGRP external, O - OSPF, IA - OSPF inter area
NL - OSPF NSSA external type 1, N2 - OSPF NSSA external type 2
E1 - OSPF external type 1, E2 - OSPF external type 2
i - IS-IS, su - IS-IS summary, L1 - IS-IS level-1, L2 - IS-IS level-2
ia - IS-IS inter area, * - candidate default, U - per-user static route
o - ODR, P - periodic downloaded static route, H - NHRP, l - LISP
+ - replicated route, % - next hop override

Gateway of last resort is not set

R1#copy running-config startup-config
Destination filename [startup-config]?
Warning: Attempting to overwrite an NVRAM configuration previously written
by a different version of the system image.
Overwrite the previous NVRAM configuration?[confirm]
Building configuration...
[OK]
R1#
R1#
R1#
```

```
R2#enable
R2#conf terminal
R2(config)#hostname R2
R2(config)# no ip domain-lookup
R2(config)# line con 0
R2(config-line)# logging synchronous
R2(config-line)# exec-timeout 0 0
R2(config-line)# exit
R2(config)#interface s2/0
R2(config-if)#ip address 10.113.12.2 255.255.255.0
R2(config-if)#no shutdown
R2(config-if)#interface s2/1
R2(config-if)#ip address 10.113.13.1 255.255.255.0
R2(config-if)#no shutdown
R2(config-if)#exit
```

```

R2(config)#router ospf 1
R2(config-router)#router-id 2.2.2.2
R2(config-router)#network 10.113.12.0 0.0.0.255 area 5
R2(config-router)#network 10.113.13.0 0.0.0.255 area 5
R2(config-if)# end
R2#show ip route
R2#copy running-config startup-config

```

Figura 4. Configuración Router 2

```

R2#ena
R2#conf ter
Enter configuration commands, one per line. End with CNTL/Z.
R2(config)#hostn R2
R2(config)#no ip domain-lookup
R2(config)#line con 0
R2(config-line)#logging synchronous
R2(config-line)#exec-timeout 0 0
R2(config-line)#exit
R2(config)#interface s2/0
R2(config-if)#ip address 10.113.12.2 255.255.255.0
R2(config-if)#no shut
R2(config-if)#interface s2/1
R2(config-if)#ip address 10.113.13.1 255.255.255.0
R2(config-if)#no shut
R2(config-if)#exit
R2(config)#
R2(config)#
R2(config)#
R2(config)#router ospf 1
R2(config-router)#router-id 2.2.2.2
R2(config-router)#network 10.113.12.0 0.0.0.255 area 5
R2(config-router)#network 10.113.13.0 0.0.0.255 area 5
R2(config-router)#^Z

R2#show ip route
Codes: L - local, C - connected, S - static, R - RIP, M - mobile, B - BGP
       D - EIGRP, EX - EIGRP external, O - OSPF, IA - OSPF inter area
       N1 - OSPF NSSA external type 1, N2 - OSPF NSSA external type 2
       E1 - OSPF external type 1, E2 - OSPF external type 2
       I - IS-IS, su - IS-IS summary, L1 - IS-IS level-1, L2 - IS-IS level-2
       Ia - IS-IS inter area, * - candidate default, U - per-user static route
       o - ODR, P - periodic downloaded static route, H - NHRP, l - LISP
       + - replicated route, % - next hop override

Gateway of last resort is not set

  10.0.0.0/8 is variably subnetted, 2 subnets, 2 masks
C       10.113.12.0/24 is directly connected, Serial2/0
L       10.113.12.2/32 is directly connected, Serial2/0
R2#copy running-config startup-config
Destination filename [startup-config]?
R2#copy running-config startup-config
R2#copy running-config startup-config
Warning: Attempting to overwrite an NVRAM configuration previously written
by a different version of the system image.
Overwrite the previous NVRAM configuration?[confirm]
Building configuration...
[OK]

```

```

R3#enable
R3#conf terminal
R3(config)#hostname R3
R3(config)# no ip domain-lookup
R3(config)# line con 0
R3(config-line)# logging synchronous
R3(config-line)# exec-timeout 0 0
R3(config-line)# exit
R3(config)#interface s2/0
R3(config-if)#bandwidth 128000
R3(config-if)#ip address 10.113.13.2 255.255.255.0
R3(config-if)#no shutdown
R3(config-if)#int s2/1
R3(config-if)#ip address 172.19.34.1 255.255.255.0
R3(config-if)#no shutdown
R3(config-if)#exit
R3(config)#router ospf 1
R3(config-router)#router-id 3.3.3.3
R3(config-router)#network 10.113.13.0 0.0.0.255 area 5
R3(config-router)#exit

```

```

R3(config)#router eigrp 15
R3(config-router)#network 172.19.34.0 0.0.0.255
R3(config-router)#no auto-summary
R3(config-if)# end
R3#show ip route
R3#copy running-config startup-config

```

Figura 5. Configuración Router 3

```

R3#ena
R3#conf t
Enter configuration commands, one per line. End with CNTL/Z.
R3(config)#hostname R3
R3(config)#no ip domain-lookup
R3(config)#line con 0
R3(config-line)#logging synchronous
R3(config-line)#exec-timeout 0 0
R3(config-line)#exit
R3(config)#interface s2/0
R3(config-if)#bandwidth 128000
R3(config-if)#ip address 10.113.13.2 255.255.255.0
R3(config-if)#no shut
R3(config-if)#
*Oct 17 11:14:54.043: %LINK-3-UPDOWN: Interface Serial2/0, changed state to up
R3(config-if)#
*Oct 17 11:14:55.051: %LINEPROTO-5-UPDOWN: Line protocol on Interface Serial2/0, cha
nged state to up
R3(config-if)#
R3(config-if)#int s2/1
R3(config-if)#ip address 172.19.34.1 255.255.255.0
R3(config-if)#no shut
R3(config-if)#exit
*Oct 17 11:15:20.415: %LINK-3-UPDOWN: Interface Serial2/1, changed state to up
R3(config-if)#exit
R3(config)#
*Oct 17 11:15:21.423: %LINEPROTO-5-UPDOWN: Line protocol on Interface Serial2/1, cha
nged state to up
R3(config)#
R3(config)#Z
R3#
*Oct 17 11:15:27.999: %SYS-5-CONFIG_I: Configured from console by console
R3#
R3#
R3#conf
*Oct 17 11:15:43.215: %LINEPROTO-5-UPDOWN: Line protocol on Interface Serial2/1, cha
nged state to down
R3#conf t
Enter configuration commands, one per line. End with CNTL/Z.
R3(config)#router ospf 1
R3(config-router)#router-id 3.3.3.3
R3(config-router)#network 10.113.13.0 0.0.0.255 area 5
R3(config-router)#
*Oct 17 11:16:17.299: %OSPF-5-ADJCHG: Process 1, Nbr 2.2.2.2 on Serial2/0 from LOADI
NG to FULL, Loading Done
R3(config-router)#exit
R3(config)#
R3(config)#router eigrp 15
R3(config-router)#network 172.19.34.0 0.0.0.255
R3(config-router)#no auto-summary
R3(config-router)#^Z
R3#
R3#
*Oct 17 11:17:00.291: %SYS-5-CONFIG_I: Configured from console by console
R3#show ip route
Codes: L - local, C - connected, S - static, R - RIP, M - mobile, B - BGP
D - EIGRP, EX - EIGRP external, O - OSPF, IA - OSPF inter area
N1 - OSPF NSSA external type 1, N2 - OSPF NSSA external type 2
E1 - OSPF external type 1, E2 - OSPF external type 2
i - IS-IS, su - IS-IS summary, L1 - IS-IS level-1, L2 - IS-IS level-2
ia - IS-IS inter area, * - candidate default, U - per-user static route
o - ODR, P - periodic downloaded static route, H - NHRP, I - LISP
+ - replicated route, % - next hop override

Gateway of last resort is not set

10.0.0.0/8 is variably subnetted, 3 subnets, 2 masks
O 10.113.12.0/24 [110/65] via 10.113.13.1, 00:00:46, Serial2/0
C 10.113.13.0/24 is directly connected, Serial2/0
L 10.113.13.2/32 is directly connected, Serial2/0
R3#copy running-config startup-config
Destination filename [startup-config]?
Warning: Attempting to overwrite an NVRAM configuration previously written
by a different version of the system image.
Overwrite the previous NVRAM configuration?[confirm]
Building configuration...
[OK]
R3#

```

```

R4#enable
R4#conf terminal
R4(config)#hostname R4
R4(config)# no ip domain-lookup
R4(config)# line con 0
R4(config-line)# logging synchronous
R4(config-line)# exec-timeout 0 0
R4(config-line)# exit
R4(config)#interface s0/0
R4(config-if)#ip address 172.19.34.2 255.255.255.0
R4(config-if)#no shutdown
R4(config-if)#interface s0/1
R4(config-if)#ip address 172.19.45.1 255.255.255.0
R4(config-if)#no shutdown
R4(config-if)#exit
R4(config)#router eigrp 15
R4(config-router)#network 172.19.34.0 0.0.0.255

```

```

R4(config-if)#
R4(config-router)#network 172.19.45.0 0.0.0.255
R4(config-router)#no auto-summary
R4(config-if)# end
R4#show ip route
R4#copy running-config startup-config

```

Figura 6. Configuración Router 4

```

R4#
R4#ena
R4#conf t
Enter configuration commands, one per line. End with CNTL/Z.
R4(config)#hostname R4
R4(config)#no ip domain-lookup
R4(config)#line con 0
R4(config-line)#logging synchronous
R4(config-line)#exec-timeout 0 0
R4(config)#interface s2/0
R4(config-if)#ip address 172.19.34.2 255.255.255.0
R4(config-if)#no shut
R4(config-if)#
*Oct 17 11:20:34.723: %LINK-3-UPDOWN: Interface Serial2/0, changed state to up
R4(config-if)#
R4(config-if)#interface s2/1
R4(config-if)#ip address 172.19.45.1 255.255.255.0
R4(config-if)#no shut
R4(config-if)#
*Oct 17 11:20:35.167: %LINK-3-UPDOWN: Interface Serial2/1, changed state to up
R4(config-if)#
*Oct 17 11:20:57.175: %LINEPROTO-5-UPDOWN: Line protocol on Interface Serial2/1, changed state to up
R4(config-if)#exit

R4(config)#router eigrp 15
R4(config-router)#network 172.19.34.0 0.0.0.255
R4(config-router)#
*Oct 17 11:21:24.107: %LINEPROTO-5-UPDOWN: Line protocol on Interface Serial2/1, changed state to down
R4(config-router)#
*Oct 17 11:21:24.415: %DUAL-S-NBRCHANGE: EIGRP-IP4v4 15: Neighbor 172.19.34.1 (Serial2/0) is up: new adjacency
R4(config-router)#network 172.19.45.0 0.0.0.255
R4(config-router)#no auto-summary
R4(config-router)#?
R4#
*Oct 17 11:21:50.507: %SYS-5-CONFIG_I: Configured from console by console
R4#show ip route
Codes: L - local, C - connected, S - static, R - RIP, M - mobile, B - BGP
D - EIGRP, EX - EIGRP external, O - OSPF, IA - OSPF inter area
N1 - OSPF NSSA external type 1, N2 - OSPF NSSA external type 2
E1 - OSPF external type 1, E2 - OSPF external type 2
I - IS-IS, su - IS-IS summary, L1 - IS-IS level-1, L2 - IS-IS level-2
Ia - IS-IS inter area, * - candidate default, U - per-user static route
o - ODR, P - periodic downloaded static route, H - NHRP, I - IGRP
* - replicated route, % - next hop override

Gateway of last resort is not set

172.19.0.0/16 is variably subnetted, 2 subnets, 2 masks
C       172.19.34.0/24 is directly connected, Serial2/0
C       172.19.34.2/32 is directly connected, Serial2/0
R4#copy running-config startup-config
Destination filename [startup-config]?
Warning: Attempting to overwrite an NVRAM configuration previously written by a different version of the system image.
Overwrite the previous NVRAM configuration?[confirm]
Building configuration...
[OK]
R4#

```

```

R5#enable
R5#conf terminal
R5(config)#hostname R5
R5(config)# no ip domain-lookup
R5(config)# line con 0
R5(config-line)# logging synchronous
R5(config-line)# exec-timeout 0 0
R5(config-line)# exit
R5(config)#interface s0/0
R5(config-if)#bandwidth 128000
R5(config-if)#ip address 172.19.45.2 255.255.255.0
R5(config-if)#no shutdown
R5(config-if)#exit
R5(config)#router eigrp 15
R5(config-router)#network 172.19.45.0 0.0.0.255
R5(config-router)#no auto-summary
R5(config-if)# end
R5#show ip route
R5#copy running-config startup-config

```

Figura 7. Configuración Router 5

```

R5#
R5#name
R5#conf t
Enter configuration commands, one per line. End with CNTL/Z.
R5(config)#hostname R5
R5(config)#no ip domain-lookup
R5(config)#line con 0
R5(config-line)#logging synchronous
R5(config-line)#exec-timeout 0 0
R5(config-line)#exit
R5(config)#interface s2/0
R5(config-if)#bandwidth 128000
R5(config-if)#ip address 172.19.45.2 255.255.255.0
R5(config-if)#no shut
R5(config-if)#
*Oct 17 12:02:33.855: XLINK-3-UPDOWN: Interface Serial2/0, changed state to up
R5(config-if)#
*Oct 17 12:02:34.863: XLINEPROTO-5-UPDOWN: Line protocol on Interface Serial2/0, changed state to up
R5(config-if)#exit
R5(config)#
R5(config)#
R5(config)#router eigrp 15
R5(config-router)#network 172.19.45.0 0.0.0.255
R5(config-router)#
*Oct 17 12:03:00.291: NDUAL-5-NBRCHANGE: EIGRP-IPv4 15: Neighbor 172.19.45.1 (Serial2/0) is up: new adjacency
R5(config-router)#no auto-summary
R5(config-router)#2

R5#show ip route
Codes: L - local, C - connected, S - static, R - RIP, M - mobile, B - BGP
       D - EIGRP, EX - EIGRP external, O - OSPF, IA - OSPF inter area
       N1 - OSPF NSSA external type 1, N2 - OSPF NSSA external type 2
       E1 - OSPF external type 1, E2 - OSPF external type 2
       I - IS-IS, su - IS-IS summary, L1 - IS-IS level-1, L2 - IS-IS level-2
       ia - IS-IS inter area, * - candidate default, U - per-user static route
       o - ODR, P - periodic downloaded static route, H - NHRP, l - LISP
       + - replicated route, % - next hop override

Gateway of last resort is not set

    172.19.0.0/16 is variably subnetted, 3 subnets, 2 masks
       D       172.19.34.0/24 [90/2681856] via 172.19.45.1, 00:00:21, Serial2/0
       C       172.19.45.0/24 is directly connected, Serial2/0
       L       172.19.45.2/32 is directly connected, Serial2/0
R5#copy running-config startup-config
Destination filename [startup-config]?
Warning: Attempting to overwrite an NVRAM configuration previously written
by a different version of the system image.
Overwrite the previous NVRAM configuration?[confirm]
Building configuration...
[OK]
R5#

```

2. Cree cuatro nuevas interfaces de Loopback en R1 utilizando la asignación de direcciones 10.1.0.0/22 y configure esas interfaces para participar en el área 5 de OSPF.

Tabla 2. Configuraciones para Loopback en Router R1

Device	Interface	IP Address	Subnet Mask
R1	loopback 0	10.1.0.10	255.255.255.0
	loopback 1	10.1.1.10	255.255.255.0
	loopback 2	10.1.2.10	255.255.255.0
	loopback 3	10.1.3.10	255.255.255.0

```

R1(config)#interface loopback 0
R1(config-if)#ip address 10.1.0.10 255.255.255.0
R1(config-if)#interface loopback 1
R1(config-if)#ip address 10.1.1.10 255.255.255.0
R1(config-if)#interface loopback 2
R1(config-if)#ip address 10.1.2.10 255.255.255.0
R1(config-if)#interface loopback 3
R1(config-if)#ip address 10.1.3.10 255.255.255.0
R1(config-if)#exit

```

```

R1(config)#router ospf 1
R1(config-router)#network 10.1.0.0 0.0.0.255 area 5
R1(config-router)#network 10.1.1.0 0.0.0.255 area 5
R1(config-router)#network 10.1.2.0 0.0.0.255 area 5
R1(config-router)#network 10.1.3.0 0.0.0.255 area 5

```

Figura 8. Configuración Loopback y OSPF en Router R1

```

R1#conf t
Enter configuration commands, one per line. End with CNTL/Z.
R1(config)#
R1(config)#
R1(config)#interface loopback 0
R1(config-if)#
*Oct 17 12:51:42.191: %LINEPROTO-5-UPDOWN: Line protocol on Interface Loopback0, changed state to up
R1(config-if)#ip address 10.1.0.10 255.255.255.0
R1(config-if)#interface loopback 1
R1(config-if)#
*Oct 17 12:52:01.207: %LINEPROTO-5-UPDOWN: Line protocol on Interface Loopback1, changed state to up
R1(config-if)#ip address 10.1.1.10 255.255.255.0
R1(config-if)#interface loopback 2
R1(config-if)#
*Oct 17 12:52:20.119: %LINEPROTO-5-UPDOWN: Line protocol on Interface Loopback2, changed state to up
R1(config-if)#ip address 10.1.2.10 255.255.255.0
R1(config-if)#interface loopback 3
R1(config-if)#
*Oct 17 12:52:34.831: %LINEPROTO-5-UPDOWN: Line protocol on Interface Loopback3, changed state to up
R1(config-if)#ip address 10.1.3.10 255.255.255.0
R1(config-if)#exit
R1(config)#
R1(config)#
R1(config)#router ospf 1
R1(config-router)#network 10.1.0.0 0.0.0.255 area 5
R1(config-router)#network 10.1.1.0 0.0.0.255 area 5
R1(config-router)#network 10.1.2.0 0.0.0.255 area 5
R1(config-router)#network 10.1.3.0 0.0.0.255 area 5
R1(config-router)#

```

3. Cree cuatro nuevas interfaces de Loopback en R5 utilizando la asignación de direcciones 172.5.0.0/22 y configure esas interfaces para participar en el Sistema Autónomo EIGRP 15.

Tabla 3. Configuraciones de Loopback en Router R5

Device	Interface	IP Address	Subnet Mask
R5	loopback 0	172.5.0.10	255.255.255.0
	loopback 1	172.5.1.10	255.255.255.0
	loopback 2	172.5.2.10	255.255.255.0
	loopback 3	172.5.3.10	255.255.255.0

```

R5(config)#interface loopback 0
R5(config-if)#ip address 10.5.0.10 255.255.255.0
R5(config-if)#interface loopback 1
R5(config-if)#ip address 10.5.1.10 255.255.255.0
R5(config-if)#interface loopback 2
R5(config-if)#ip address 10.5.2.10 255.255.255.0
R5(config-if)#interface loopback 3
R5(config-if)#ip address 10.5.3.10 255.255.255.0
R5(config-if)#exit

```

```

R5(config)#router eigrp 15
R5(config-router)#network 10.5.0.0 0.0.0.255
R5(config-router)#network 10.5.1.0 0.0.0.255
R5(config-router)#network 10.5.2.0 0.0.0.255
R5(config-router)#network 10.5.3.0 0.0.0.255
R5(config)#exit

```

Figura 9. Configuración Loopback y EIGRP 15 en Router R5

```

R5#conf t
Enter configuration commands, one per line. End with CNTL/Z.
R5(config)#interface loopback 0
R5(config-if)#
*Oct 17 12:31:43.375: %LINEPROTO-5-UPDOWN: Line protocol on Interface Loopback0, cha
nged state to up
R5(config-if)#ip address 10.5.0.10 255.255.255.0
R5(config-if)#interface loopback 1
R5(config-if)#
*Oct 17 12:31:56.587: %LINEPROTO-5-UPDOWN: Line protocol on Interface Loopback1, cha
nged state to up
R5(config-if)#ip address 10.5.1.10 255.255.255.0
R5(config-if)#interface loopback 2
R5(config-if)#
*Oct 17 12:32:10.207: %LINEPROTO-5-UPDOWN: Line protocol on Interface Loopback2, cha
nged state to up
R5(config-if)#ip address 10.5.2.10 255.255.255.0
R5(config-if)#interface loopback 3
R5(config-if)#
*Oct 17 12:32:24.403: %LINEPROTO-5-UPDOWN: Line protocol on Interface Loopback3, cha
nged state to up
R5(config-if)#ip address 10.5.3.10 255.255.255.0
R5(config-if)#exit
R5(config)#
R5(config)#
R5(config)#router eigrp 15
R5(config-router)#network 10.5.0.0 0.0.0.255
R5(config-router)#network 10.5.1.0 0.0.0.255
R5(config-router)#network 10.5.2.0 0.0.0.255
R5(config-router)#network 10.5.3.0 0.0.0.255
R5(config-router)#exit
R5(config)#

```

4. Analice la tabla de enrutamiento de R3 y verifique que R3 está aprendiendo las nuevas interfaces de Loopback mediante el comando **show ip route**.

```
R3#show ip route
```

Figura 10. Route R3 aprendiendo las nuevas interfaces Loopback

```

R3#show ip route
Codes: L - local, C - connected, S - static, R - RIP, M - mobile, B - BGP
D - EIGRP, EX - EIGRP external, O - OSPF, IA - OSPF inter area
N1 - OSPF NSSA external type 1, N2 - OSPF NSSA external type 2
E1 - OSPF external type 1, E2 - OSPF external type 2
I - IS-IS, su - IS-IS summary, L1 - IS-IS level-1, L2 - IS-IS level-2
ia - IS-IS inter area, * - candidate default, U - per-user static route
o - ODR, P - periodic downloaded static route, H - NHRP, l - LISP
+ - replicated route, % - next hop override

Gateway of last resort is not set

10.0.0.0/8 is variably subnetted, 11 subnets, 2 masks
O 10.1.0.10/32 [110/66] via 10.113.13.1, 00:10:08, Serial2/0
O 10.1.1.10/32 [110/66] via 10.113.13.1, 00:09:58, Serial2/0
O 10.1.2.10/32 [110/66] via 10.113.13.1, 00:09:48, Serial2/0
O 10.1.3.10/32 [110/66] via 10.113.13.1, 00:09:38, Serial2/0
D 10.5.0.0/24 [90/2809856] via 172.19.34.2, 00:05:29, Serial2/1
D 10.5.1.0/24 [90/2809856] via 172.19.34.2, 00:05:23, Serial2/1
D 10.5.2.0/24 [90/2809856] via 172.19.34.2, 00:05:18, Serial2/1
D 10.5.3.0/24 [90/2809856] via 172.19.34.2, 00:05:11, Serial2/1
O 10.113.12.0/24 [110/65] via 10.113.13.1, 01:30:00, Serial2/0
C 10.113.13.0/24 is directly connected, Serial2/0
L 10.113.13.2/32 is directly connected, Serial2/0
L 172.19.0.0/16 is variably subnetted, 3 subnets, 2 masks
C 172.19.34.0/24 is directly connected, Serial2/1
L 172.19.34.1/32 is directly connected, Serial2/1
D 172.19.45.0/24 [90/2681856] via 172.19.34.2, 00:35:48, Serial2/1
R3#

```

5. Configure R3 para redistribuir las rutas EIGRP en OSPF usando el costo de 50000 y luego redistribuya las rutas OSPF en EIGRP usando un ancho de banda T1 y 20,000 microsegundos de retardo.

```
R3(config)#router ospf 1
R3(config-router)# redistribute eigrp 15 subnets
R3(config-router)# exit
```

```
R3(config)#router eigrp 15
R3(config-router)# redistribute ospf 1 metric 1500 20000 255 1 1500
R3#copy running-config startup-config
```

Figura 11. Configuración en Router R3 - EIGRP en OSPF

```
R3#conf t
Enter configuration commands, one per line. End with CNTL/Z.
R3(config)#router ospf 1
R3(config-router)#redistribute eigrp 15 subnets
R3(config-router)#exit
R3(config)#
R3(config)#
R3(config)#router eigrp 15
R3(config-router)#redistribute ospf 1 metric 1500 20000 255 1 1500
R3(config-router)#
R3(config-router)#^Z
R3#
R3#
*Oct 17 12:53:39.035: %SYS-5-CONFIG I: Configured from console by console
R3#copy running-config startup-config
Destination filename [startup-config]?
Building configuration...
[OK]
R3#
```

6. Verifique en R1 y R5 que las rutas del sistema autónomo opuesto existen en su tabla de enrutamiento mediante el comando **show ip route**.

```
R1# show ip route
```

Figura 12. Verificación en Router R1

```
R1#show ip route
Codes: L - local, C - connected, S - static, R - RIP, M - mobile, B - BGP
D - EIGRP, EX - EIGRP external, O - OSPF, IA - OSPF inter area
N1 - OSPF NSSA external type 1, N2 - OSPF NSSA external type 2
E1 - OSPF external type 1, E2 - OSPF external type 2
i - IS-IS, su - IS-IS summary, L1 - IS-IS level-1, L2 - IS-IS level-2
ia - IS-IS inter area, * - candidate default, U - per-user static route
o - ODR, P - periodic downloaded static route, H - NHRP, I - LISP
+ - replicated route, % - next hop override

Gateway of last resort is not set

10.0.0.0/8 is variably subnetted, 15 subnets, 2 masks
C    10.1.0.0/24 is directly connected, Loopback0
L    10.1.0.10/32 is directly connected, Loopback0
C    10.1.1.0/24 is directly connected, Loopback1
L    10.1.1.10/32 is directly connected, Loopback1
C    10.1.2.0/24 is directly connected, Loopback2
L    10.1.2.10/32 is directly connected, Loopback2
C    10.1.3.0/24 is directly connected, Loopback3
L    10.1.3.10/32 is directly connected, Loopback3
O E2 10.5.0.0/24 [110/20] via 10.113.12.2, 00:03:16, Serial2/0
O E2 10.5.1.0/24 [110/20] via 10.113.12.2, 00:03:16, Serial2/0
O E2 10.5.2.0/24 [110/20] via 10.113.12.2, 00:03:16, Serial2/0
O E2 10.5.3.0/24 [110/20] via 10.113.12.2, 00:03:16, Serial2/0
C    10.113.12.0/24 is directly connected, Serial2/0
L    10.113.12.1/32 is directly connected, Serial2/0
O    10.113.13.0/24 [110/65] via 10.113.12.2, 01:41:25, Serial2/0
L    172.19.0.0/24 is subnetted, 2 subnets
O E2 172.19.34.0 [110/20] via 10.113.12.2, 00:03:16, Serial2/0
O E2 172.19.45.0 [110/20] via 10.113.12.2, 00:03:16, Serial2/0
R1#
```

R5# show ip route

Figura 13. Verificación en Router R5

```
R5#show ip route
Codes: L - local, C - connected, S - static, R - RIP, M - mobile, B - BGP
D - EIGRP, EX - EIGRP external, O - OSPF, IA - OSPF inter area
N1 - OSPF NSSA external type 1, N2 - OSPF NSSA external type 2
E1 - OSPF external type 1, E2 - OSPF external type 2
i - IS-IS, su - IS-IS summary, L1 - IS-IS level-1, L2 - IS-IS level-2
ia - IS-IS inter area, * - candidate default, U - per-user static route
o - ODR, P - periodic downloaded static route, H - NHRP, l - LISP
+ - replicated route, % - next hop override

Gateway of last resort is not set

10.0.0.0/8 is variably subnetted, 14 subnets, 2 masks
D EX 10.1.0.10/32 [170/7850496] via 172.19.45.1, 00:03:26, Serial2/0
D EX 10.1.1.10/32 [170/7850496] via 172.19.45.1, 00:03:26, Serial2/0
D EX 10.1.2.10/32 [170/7850496] via 172.19.45.1, 00:03:26, Serial2/0
D EX 10.1.3.10/32 [170/7850496] via 172.19.45.1, 00:03:26, Serial2/0
C 10.5.0.0/24 is directly connected, Loopback0
L 10.5.0.10/32 is directly connected, Loopback0
C 10.5.1.0/24 is directly connected, Loopback1
L 10.5.1.10/32 is directly connected, Loopback1
C 10.5.2.0/24 is directly connected, Loopback2
L 10.5.2.10/32 is directly connected, Loopback2
C 10.5.3.0/24 is directly connected, Loopback3
L 10.5.3.10/32 is directly connected, Loopback3
D EX 10.113.12.0/24 [170/7850496] via 172.19.45.1, 00:03:26, Serial2/0
D EX 10.113.13.0/24 [170/7850496] via 172.19.45.1, 00:03:26, Serial2/0
172.19.0.0/16 is variably subnetted, 3 subnets, 2 masks
D 172.19.34.0/24 [90/2681856] via 172.19.45.1, 00:45:57, Serial2/0
C 172.19.45.0/24 is directly connected, Serial2/0
L 172.19.45.2/32 is directly connected, Serial2/0
R5#
```

Escenario 2

Una empresa de comunicaciones presenta una estructura Core acorde a la topología de red, en donde el estudiante será el administrador de la red, el cual deberá configurar e interconectar entre sí cada uno de los dispositivos que forman parte del escenario, acorde con los lineamientos establecidos para el direccionamiento IP, etherchannels, VLANs y demás aspectos que forman parte del escenario propuesto.

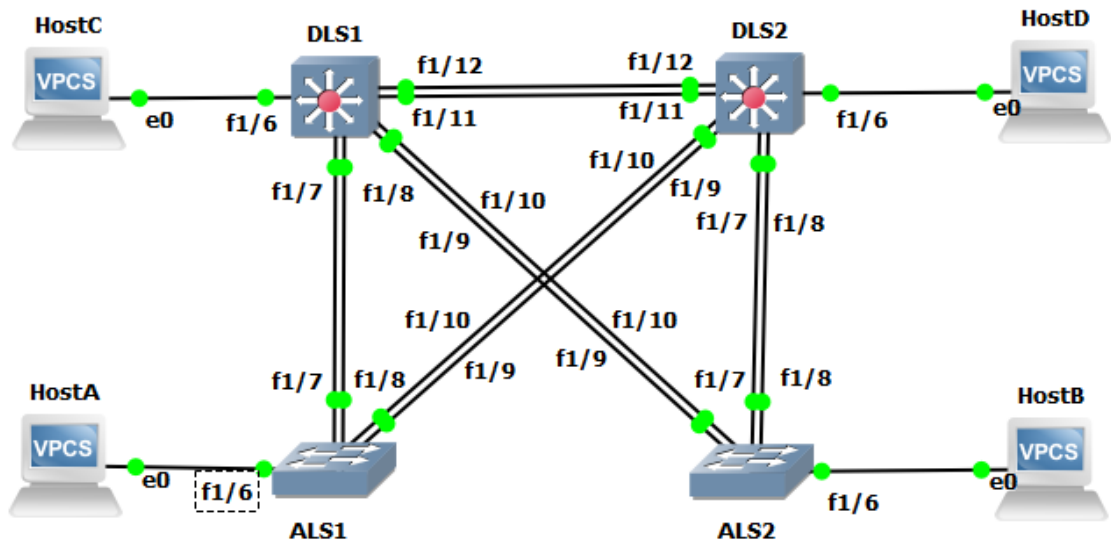
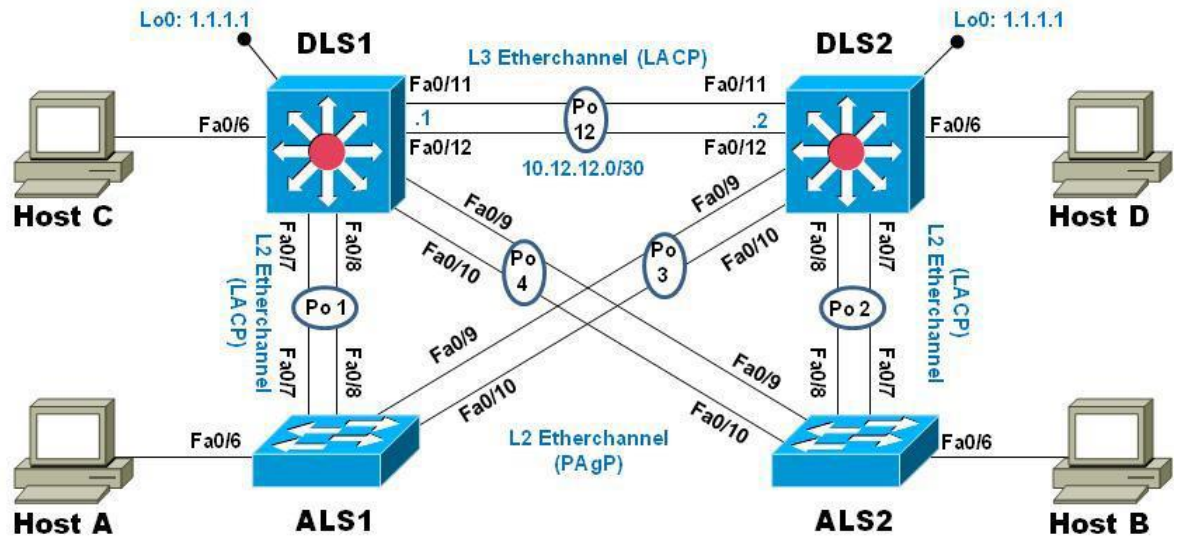

Parte 1: Configurar la red de acuerdo con las especificaciones.

- a. Apagar todas las interfaces en cada switch.

```
ALS1#conf t
Enter configuration commands, one per line. End with CNTL/Z.
ALS1(config)#int range f0/0 - 1 , f1/1 - 5 , f1/11 - 15
ALS1(config-if-range)#shutdown
```

```
ALS2#conf t
Enter configuration commands, one per line. End with CNTL/Z.
ALS2(config)#int range f0/0 - 1 , f1/1 - 5 , f1/11 - 15
ALS2(config-if-range)#shutdown
```

```
DLS1#conf t
Enter configuration commands, one per line. End with CNTL/Z.
DLS1(config)#int range f0/0 - 1 , f1/1 - 5 , f1/13 - 15
DLS1(config-if-range)#shutdown
```

```
DLS2#conf t
Enter configuration commands, one per line. End with CNTL/Z.
DLS2(config)#int range f0/0 - 1 , f1/1 - 5 , f1/13 - 15
DLS2(config-if-range)#shutdown
```

Figura 14 Configuración inicial switch

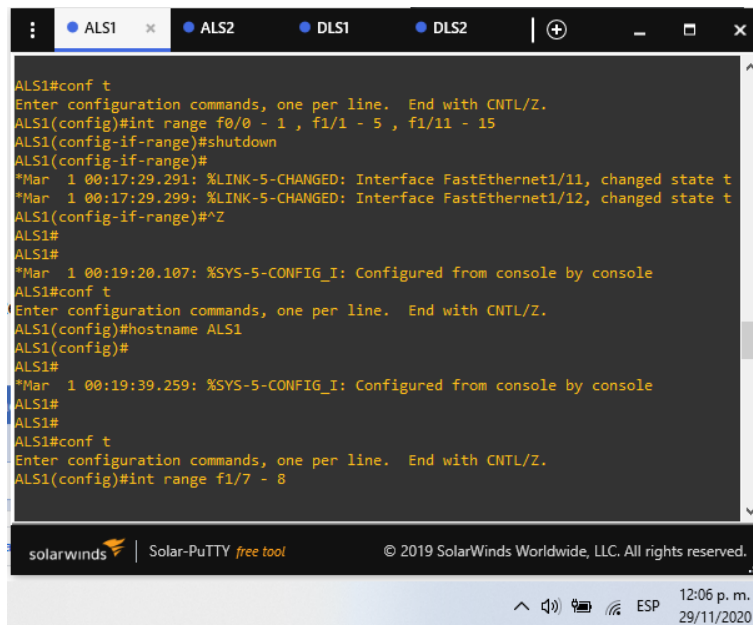

```
ALS1#conf t
Enter configuration commands, one per line. End with CNTL/Z.
ALS1(config)#int range f0/0 - 1 , f1/1 - 5 , f1/11 - 15
ALS1(config-if-range)#shutdown
ALS1(config-if-range)#
*Mar 1 00:17:29.291: %LINK-5-CHANGED: Interface FastEthernet1/11, changed state t
*Mar 1 00:17:29.299: %LINK-5-CHANGED: Interface FastEthernet1/12, changed state t
ALS1(config-if-range)^Z
ALS1#
ALS1#
*Mar 1 00:19:20.107: %SYS-5-CONFIG_I: Configured from console by console
ALS1#conf t
Enter configuration commands, one per line. End with CNTL/Z.
ALS1(config)#hostname ALS1
ALS1(config)#
ALS1#
*Mar 1 00:19:39.259: %SYS-5-CONFIG_I: Configured from console by console
ALS1#
ALS1#
ALS1#conf t
Enter configuration commands, one per line. End with CNTL/Z.
ALS1(config)#int range f1/7 - 8
```

- b. Asignar un nombre a cada switch acorde con el escenario establecido.

```
ALS1#conf t
Enter configuration commands, one per line. End with CNTL/Z.
ALS1(config)#hostname ALS1
```

```
ALS2#conf t
Enter configuration commands, one per line. End with CNTL/Z.
ALS2(config)#hostname ALS2
```

```
DLS1#conf t
Enter configuration commands, one per line. End with CNTL/Z.
DLS1(config)#hostname DLS1
```

```
DLS2#conf t
Enter configuration commands, one per line. End with CNTL/Z.
DLS2(config)#hostname DLS2
```

- c. Configurar los puertos troncales y Port-channels tal como se muestra en el diagrama.

- 1) La conexión entre DLS1 y DLS2 será un EtherChannel capa-3 utilizando LACP. Para DLS1 se utilizará la dirección IP 10.12.12.1/30 y para DLS2 utilizará 10.12.12.2/30.

```
DLS1(config)#interface port-channel 12
DLS1(config-if)# no switchport
*Mar 1 00:31:44.431: %LINEPROTO-5-UPDOWN: Line protocol on Interface
Port-channel12, changed state to down
DLS1(config-if)#ip add 10.12.12.1 255.255.255.252
DLS1(config-if)#exit
DLS1(config)#interface range f1/11 - 12
DLS1(config-if-range)#no switchport
```

```
DLS2(config)#interface port-channel 12
DLS2(config-if)# no switchport
*Mar 1 00:31:44.431: %LINEPROTO-5-UPDOWN: Line protocol on Interface
Port-channel12, changed state to down
DLS2(config-if)#ip add 10.12.12.2 255.255.255.252
DLS2(config-if)#exit
DLS2(config)#interface range f1/11 - 12
DLS2(config-if-range)#no switchport
```

Figura 15 Configuración EtherChannel capa-3

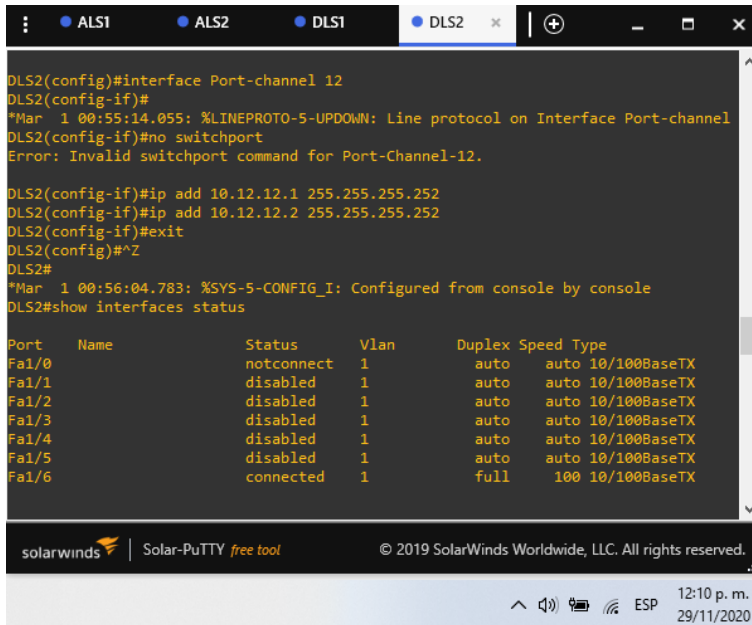

```
DLS2(config)#interface Port-channel 12
DLS2(config-if)#
*Mar 1 00:55:14.055: %LINEPROTO-5-UPDOWN: Line protocol on Interface Port-channel
DLS2(config-if)#no switchport
Error: Invalid switchport command for Port-Channel-12.

DLS2(config-if)#ip add 10.12.12.1 255.255.255.252
DLS2(config-if)#ip add 10.12.12.2 255.255.255.252
DLS2(config-if)#exit
DLS2(config)#^Z
DLS2#
*Mar 1 00:56:04.783: %SYS-5-CONFIG_I: Configured from console by console
DLS2#show interfaces status

Port  Name      Status      Vlan    Duplex  Speed  Type
Fa1/0  notconnect 1          auto    auto    10/100BaseTX
Fa1/1  disabled   1          auto    auto    10/100BaseTX
Fa1/2  disabled   1          auto    auto    10/100BaseTX
Fa1/3  disabled   1          auto    auto    10/100BaseTX
Fa1/4  disabled   1          auto    auto    10/100BaseTX
Fa1/5  disabled   1          auto    auto    10/100BaseTX
Fa1/6  connected  1          full    100    10/100BaseTX
```

2) Los Port-channels en las interfaces Fa0/7 y Fa0/8 utilizarán LACP.

```
DLS1(config)#int range f1/7 - 8
DLS1(config-if-range)#channel-group 1 mode on
```

```
DLS2(config)#int range f1/7 - 8
DLS2(config-if-range)#channel-group 1 mode on
```

```
ALS1(config)#int range f1/7 - 8
ALS1(config-if-range)#channel-group 1 mode on
```

```
ALS2(config)#int range f1/7 - 8
ALS2(config-if-range)#channel-group 1 mode on
```

Figura 16 Configuración LACP



```
ALS1#
ALS1#
*Mar 1 00:19:20.107: %SYS-5-CONFIG_I: Configured from console by console
ALS1#conf t
Enter configuration commands, one per line. End with CNTL/Z.
ALS1(config)#hostname ALS1
ALS1(config)#
ALS1#
*Mar 1 00:19:39.259: %SYS-5-CONFIG_I: Configured from console by console
ALS1#
ALS1#
ALS1#conf t
Enter configuration commands, one per line. End with CNTL/Z.
ALS1(config)#int range f1/7 - 8
ALS1(config-if-range)#channel-group 1 mode on
Creating a port-channel interface Port-channel1
ALS1(config-if-range)#
*Mar 1 01:04:48.959: %EC-5-BUNDLE: Interface Fa1/7 joined port-channel Po1
*Mar 1 01:04:49.059: %EC-5-BUNDLE: Interface Fa1/8 joined port-channel Po1
ALS1(config-if-range)#
*Mar 1 01:04:51.803: %LINEPROTO-5-UPDOWN: Line protocol on Interface Port-channel
ALS1(config-if-range)#
ALS1#
```

3) Los Port-channels en las interfaces F0/9 y fa0/10 utilizará PAgP.

```
DLS1(config)#int range f1/9 - 10
DLS1(config-if-range)#switchport trunk encapsulation dot1q
DLS1(config-if-range)#switchport mode trunk
DLS1(config-if-range)#
DLS1(config-if-range)#channel-group 1 mode on
DLS1(config-if-range)#
DLS1(config-if-range)#no shutdown
```

```
DLS2(config)#int range f1/9 - 10
DLS2(config-if-range)#switchport trunk encapsulation dot1q
DLS2(config-if-range)#switchport mode trunk
DLS2(config-if-range)#
DLS2(config-if-range)#channel-group 1 mode on
DLS2(config-if-range)#
DLS2(config-if-range)#no shutdown
```

```
ALS1(config)#int range f1/9 - 10
ALS1(config-if-range)#switchport trunk encapsulation dot1q
ALS1(config-if-range)#switchport mode trunk
ALS1(config-if-range)#
ALS1(config-if-range)#channel-group 1 mode on
ALS1(config-if-range)#
```

```
ALS1(config-if-range)#no shutdown
```

```
ALS2(config)#int range f1/9 - 10  
ALS2(config-if-range)#switchport trunk encapsulation dot1q  
ALS2(config-if-range)#switchport mode trunk  
ALS2(config-if-range)#  
ALS2(config-if-range)#channel-group 1 mode on  
ALS2(config-if-range)#  
ALS2(config-if-range)#no shutdown
```

Figura 17 Configuración interfaces F0/9 y fa0/10 con PAgP

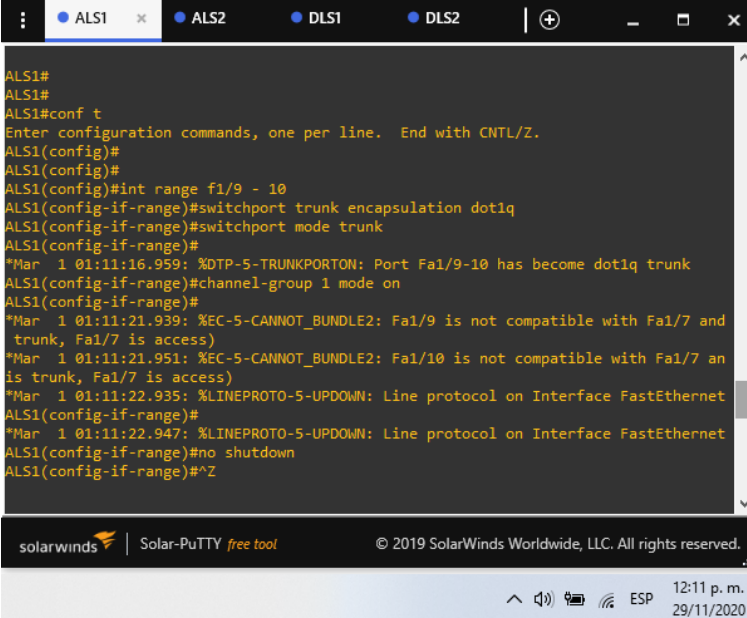

```
ALS1#  
ALS1#  
ALS1#conf t  
Enter configuration commands, one per line. End with CNTL/Z.  
ALS1(config)#  
ALS1(config)#  
ALS1(config)#int range f1/9 - 10  
ALS1(config-if-range)#switchport trunk encapsulation dot1q  
ALS1(config-if-range)#switchport mode trunk  
ALS1(config-if-range)#  
*Mar 1 01:11:16.959: %DTP-5-TRUNKPORTON: Port Fa1/9-10 has become dot1q trunk  
ALS1(config-if-range)#channel-group 1 mode on  
ALS1(config-if-range)#  
*Mar 1 01:11:21.939: %EC-5-CANNOT_BUNDLE2: Fa1/9 is not compatible with Fa1/7 and  
trunk, Fa1/7 is access)  
*Mar 1 01:11:21.951: %EC-5-CANNOT_BUNDLE2: Fa1/10 is not compatible with Fa1/7 an  
is trunk, Fa1/7 is access)  
*Mar 1 01:11:22.935: %LINEPROTO-5-UPDOWN: Line protocol on Interface FastEthernet  
ALS1(config-if-range)#  
*Mar 1 01:11:22.947: %LINEPROTO-5-UPDOWN: Line protocol on Interface FastEthernet  
ALS1(config-if-range)#no shutdown  
ALS1(config-if-range)#^Z
```

- 4) Todos los puertos troncales serán asignados a la VLAN 500 como la VLAN nativa.

```
DLS1(config)#interface Po1  
DLS1(config-if)#switchport trunk native vlan 500  
DLS1(config-if)#exit  
DLS1(config)#interface Po4  
DLS1(config-if)#switchport trunk native vlan 500  
DLS1(config-if)#exit  
DLS1(config)#
```

```
DLS2(config)#interface Po1
DLS2(config-if)#switchport trunk native vlan 500
DLS2(config-if)#exit
DLS2(config)#interface Po4
DLS2(config-if)#switchport trunk native vlan 500
DLS2(config-if)#exit
DLS2(config)#
```

```
ALS1(config)#interface Po1
ALS1(config-if)#switchport trunk native vlan 500
ALS1(config-if)#exit
ALS1(config)#interface Po4
ALS1(config-if)#switchport trunk native vlan 500
ALS1(config-if)#exit
ALS1(config)#
```

```
ALS2(config)#interface Po1
ALS2(config-if)#switchport trunk native vlan 500
ALS2(config-if)#exit
ALS2(config)#interface Po4
ALS2(config-if)#switchport trunk native vlan 500
ALS2(config-if)#exit
ALS2(config)#
```

Figura 18 Configuración Vlan 500 Nativa

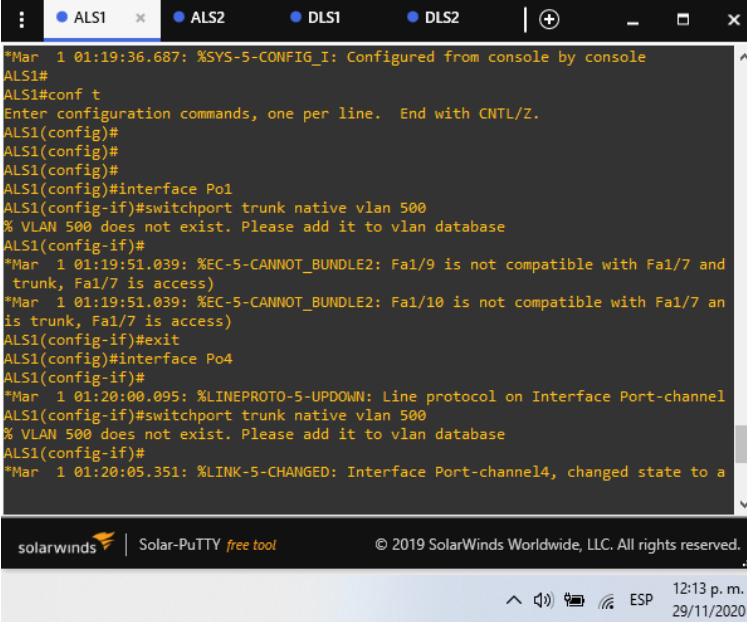

```
ALS1
ALS2
DLS1
DLS2

*Mar 1 01:19:36.687: %SYS-5-CONFIG_I: Configured from console by console
ALS1#
ALS1#conf t
Enter configuration commands, one per line. End with CNTL/Z.
ALS1(config)#
ALS1(config)#
ALS1(config)#
ALS1(config)#interface Po1
ALS1(config-if)#switchport trunk native vlan 500
% VLAN 500 does not exist. Please add it to vlan database
ALS1(config-if)#
*Mar 1 01:19:51.039: %EC-5-CANNOT_BUNDLE2: Fa1/9 is not compatible with Fa1/7 and
trunk, Fa1/7 is access)
*Mar 1 01:19:51.039: %EC-5-CANNOT_BUNDLE2: Fa1/10 is not compatible with Fa1/7 an
is trunk, Fa1/7 is access)
ALS1(config-if)#exit
ALS1(config)#interface Po4
ALS1(config-if)#
*Mar 1 01:20:00.095: %LINEPROTO-5-UPDOWN: Line protocol on Interface Port-channel
ALS1(config-if)#switchport trunk native vlan 500
% VLAN 500 does not exist. Please add it to vlan database
ALS1(config-if)#
*Mar 1 01:20:05.351: %LINK-5-CHANGED: Interface Port-channel4, changed state to a
```

solarwinds | Solar-PuTTY free tool | © 2019 SolarWinds Worldwide, LLC. All rights reserved.

12:13 p. m.
29/11/2020

d. Configurar DLS1, ALS1, y ALS2 para utilizar VTP versión 3

1) Utilizar el nombre de dominio CISCO con la contraseña ccnp321

```
DLS1(config)# vtp domain CISCO
Changing VTP domain name from NULL to CISCO
DLS1(config)# vtp password ccnp321
Setting device VLAN database password to ccnp321
DLS1(config)#
```

```
DLS2(config)#vtp domain CISCO
Changing VTP domain name from NULL to CISCO
DLS2(config)#vtp password ccnp321
Setting device VLAN database password to ccnp321
DLS2(config)#
```

```
ALS1(config)#vtp domain CISCO
Changing VTP domain name from NULL to CISCO
ALS1(config)#vtp password ccnp321
Setting device VLAN database password to ccnp321
ALS1(config)#
```

```
ALS2(config)#vtp domain CISCO
Changing VTP domain name from NULL to CISCO
ALS2(config)#vtp password ccnp321
Setting device VLAN database password to ccnp321
ALS2(config)#
```

Figura 19 Configuración nombre de dominio y contraseña

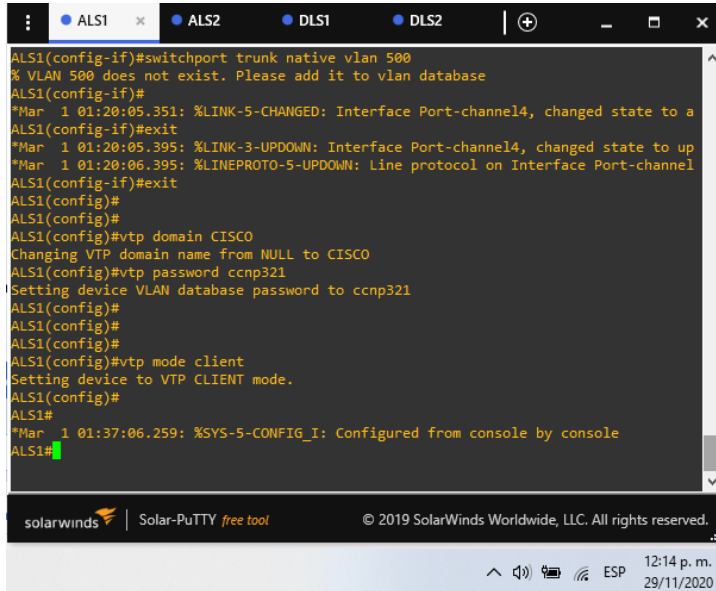

```
ALS1(config-if)#switchport trunk native vlan 500
% VLAN 500 does not exist. Please add it to vlan database
ALS1(config-if)#
*Mar 1 01:20:05.351: %LINK-5-CHANGED: Interface Port-channel4, changed state to a
ALS1(config-if)#exit
*Mar 1 01:20:05.395: %LINK-3-UPDOWN: Interface Port-channel4, changed state to up
*Mar 1 01:20:06.395: %LINEPROTO-5-UPDOWN: Line protocol on Interface Port-channel
ALS1(config-if)#exit
ALS1(config)#
ALS1(config)#
ALS1(config)#vtp domain CISCO
Changing VTP domain name from NULL to CISCO
ALS1(config)#vtp password ccnp321
Setting device VLAN database password to ccnp321
ALS1(config)#
ALS1(config)#
ALS1(config)#vtp mode client
Setting device to VTP CLIENT mode.
ALS1(config)#
ALS1#
*Mar 1 01:37:06.259: %SYS-5-CONFIG_I: Configured from console by console
ALS1#
```

2) Configurar DLS1 como servidor principal para las VLAN.

```
DLS1(config)#vtp mode server
Device mode already VTP SERVER.
```

Figura 20 Configuración DLS1 como servidor principal

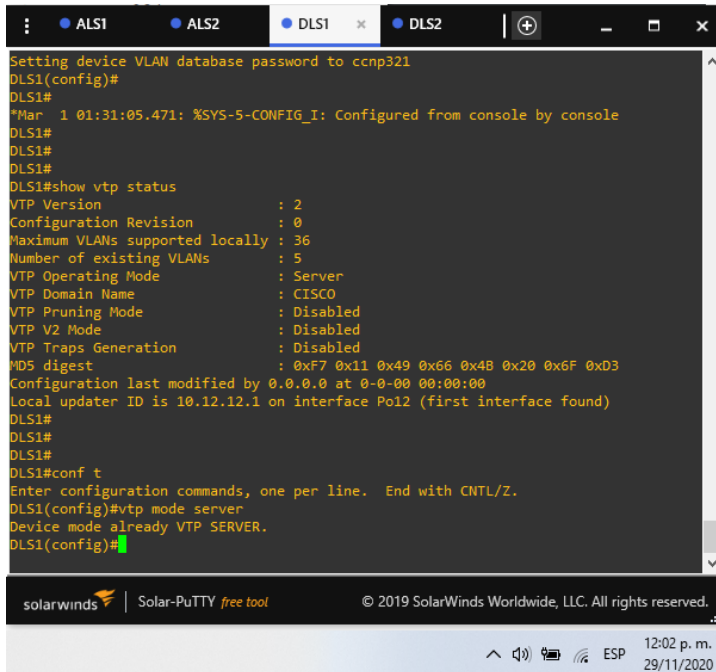

```
Setting device VLAN database password to ccnp321
DLS1(config)#
DLS1#
*Mar 1 01:31:05.471: %SYS-5-CONFIG_I: Configured from console by console
DLS1#
DLS1#
DLS1#
DLS1#show vtp status
VTP Version          : 2
Configuration Revision : 0
Maximum VLANs supported locally : 36
Number of existing VLANs : 5
VTP Operating Mode   : Server
VTP Domain Name     : CISCO
VTP Pruning Mode    : Disabled
VTP V2 Mode         : Disabled
VTP Traps Generation : Disabled
MD5 digest          : 0xF7 0x11 0x49 0x66 0x4B 0x20 0x6F 0xD3
Configuration last modified by 0.0.0.0 at 0-0-00 00:00:00
Local updater ID is 10.12.12.1 on interface Po12 (first interface found)
DLS1#
DLS1#
DLS1#
DLS1#conf t
Enter configuration commands, one per line. End with CNTL/Z.
DLS1(config)#vtp mode server
Device mode already VTP SERVER.
DLS1(config)#
```

3) Configurar ALS1 y ALS2 como clientes VTP.

```
ALS1(config)#vtp mode client
Setting device to VTP CLIENT mode.
ALS1(config)#
```

```
ALS2(config)#vtp mode client
Setting device to VTP CLIENT mode.
ALS2(config)#
```

Figura 21 Configuración clientes VTP

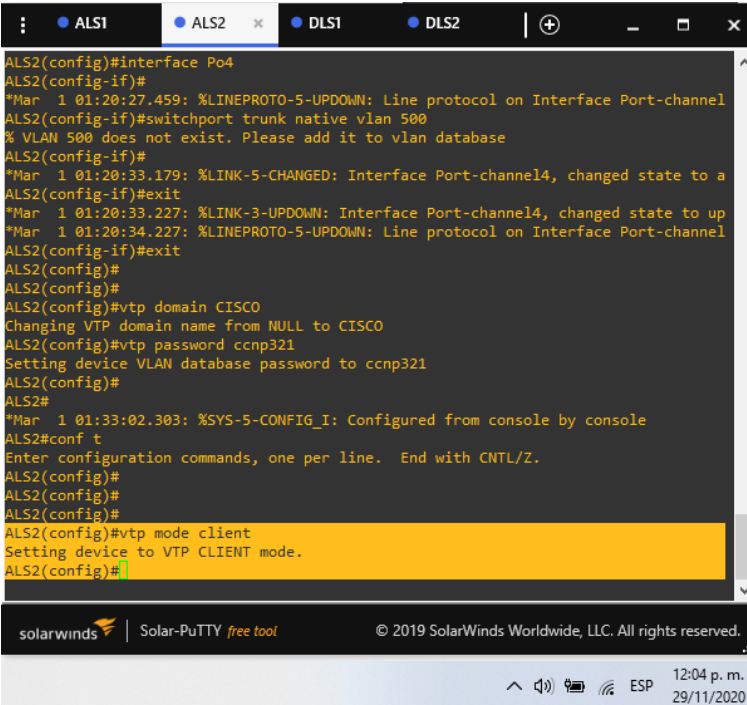

```
ALS2(config)#interface Po4
ALS2(config-if)#
*Mar 1 01:20:27.459: %LINEPROTO-5-UPDOWN: Line protocol on Interface Port-channel
ALS2(config-if)#switchport trunk native vlan 500
% VLAN 500 does not exist. Please add it to vlan database
ALS2(config-if)#
*Mar 1 01:20:33.179: %LINK-5-CHANGED: Interface Port-channel4, changed state to a
ALS2(config-if)#exit
*Mar 1 01:20:33.227: %LINK-3-UPDOWN: Interface Port-channel4, changed state to up
*Mar 1 01:20:34.227: %LINEPROTO-5-UPDOWN: Line protocol on Interface Port-channel
ALS2(config-if)#exit
ALS2(config)#
ALS2(config)#
ALS2(config)#vtp domain CISCO
Changing VTP domain name from NULL to CISCO
ALS2(config)#vtp password ccnp321
Setting device VLAN database password to ccnp321
ALS2(config)#
ALS2#
*Mar 1 01:33:02.303: %SYS-5-CONFIG_I: Configured from console by console
ALS2#conf t
Enter configuration commands, one per line. End with CNTL/Z.
ALS2(config)#
ALS2(config)#
ALS2(config)#
ALS2(config)#vtp mode client
Setting device to VTP CLIENT mode.
ALS2(config)#
```

e. Configurar en el servidor principal las siguientes VLAN:

Tabla 4 VLAN para los servidores

Número de VLAN	Nombre de VLAN	Número de VLAN	Nombre de VLAN
500	NATIVA	434	PROVEEDORES
12	ADMON	123	SEGUROS
234	CLIENTES	1010	VENTAS
1111	MULTIMEDIA	3456	PERSONAL

```

DLS1#conf t
Enter configuration commands, one per line. End with CNTL/Z.
DLS1(config)#vlan 500
DLS1(config-vlan)#name NATIVA
DLS1(config-vlan)#exit
DLS1(config)#vlan 12
DLS1(config-vlan)#name ADMON
DLS1(config-vlan)#exit
DLS1(config)#vlan 234
DLS1(config-vlan)#name CLIENTES
DLS1(config-vlan)#exit
DLS1(config)#vlan 1111
DLS1(config-vlan)#name MULTIMEDIA
DLS1(config-vlan)#exit
% Failed to create VLANs 1111
Extended VLAN(s) not allowed in current VTP mode.
%Failed to commit extended VLAN(s) changes.

DLS1(config)#
*Mar 1 01:54:32.839: %SW_VLAN-4-VLAN_CREATE_FAIL: Failed to create
VLANs 1111: extended VLAN(s) not allowed in current VTP mode
DLS1(config)#vlan 1111
DLS1(config-vlan)#name MULTIMEDIA
DLS1(config-vlan)#exit
% Failed to create VLANs 1111
Extended VLAN(s) not allowed in current VTP mode.
%Failed to commit extended VLAN(s) changes.

DLS1(config)#
*Mar 1 01:55:09.167: %SW_VLAN-4-VLAN_CREATE_FAIL: Failed to create
VLANs 1111: extended VLAN(s) not allowed in current VTP mode
DLS1(config)#vlan 434
DLS1(config-vlan)#name PROVEEDORES

```

```
DLS1(config-vlan)#exit
DLS1(config)#vlan 123
DLS1(config-vlan)#name SEGUROS
DLS1(config-vlan)#exit
DLS1(config)#vlan 1010
DLS1(config-vlan)#name VENTAS
DLS1(config-vlan)#exit
% Failed to create VLANs 1010
Extended VLAN(s) not allowed in current VTP mode.
%Failed to commit extended VLAN(s) changes.
```

```
DLS1(config)#
*Mar 1 01:56:09.639: %SW_VLAN-4-VLAN_CREATE_FAIL: Failed to create
VLANs 1010: extended VLAN(s) not allowed in current VTP mode
DLS1(config)#vlan 3456
DLS1(config-vlan)#name PERSONAL
DLS1(config-vlan)#exit
% Failed to create VLANs 3456
Extended VLAN(s) not allowed in current VTP mode.
%Failed to commit extended VLAN(s) changes.
```

```
DLS1(config)#
*Mar 1 01:56:29.863: %SW_VLAN-4-VLAN_CREATE_FAIL: Failed to create
VLANs 3456: extended VLAN(s) not allowed in current VTP mode
DLS1(config)#
```

Figura 22 Configuración de las VLAN

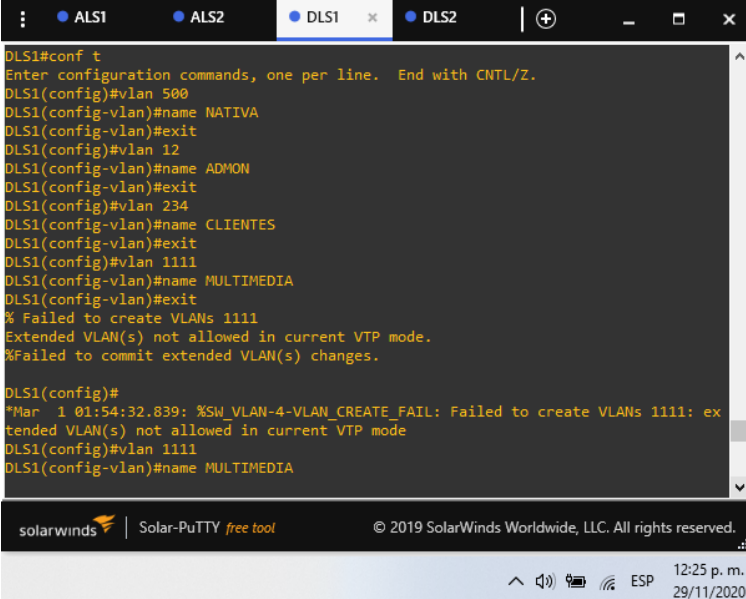

```
DLS1#conf t
Enter configuration commands, one per line. End with CNTL/Z.
DLS1(config)#vlan 500
DLS1(config-vlan)#name NATIVA
DLS1(config-vlan)#exit
DLS1(config)#vlan 12
DLS1(config-vlan)#name ADMON
DLS1(config-vlan)#exit
DLS1(config)#vlan 234
DLS1(config-vlan)#name CLIENTES
DLS1(config-vlan)#exit
DLS1(config)#vlan 1111
DLS1(config-vlan)#name MULTIMEDIA
DLS1(config-vlan)#exit
% Failed to create VLANs 1111
Extended VLAN(s) not allowed in current VTP mode.
%Failed to commit extended VLAN(s) changes.

DLS1(config)#
*Mar 1 01:54:32.839: %SW_VLAN-4-VLAN_CREATE_FAIL: Failed to create VLANs 1111: ex
tended VLAN(s) not allowed in current VTP mode
DLS1(config)#vlan 1111
DLS1(config-vlan)#name MULTIMEDIA
```

- f. En DLS1, suspender la VLAN 434.

```
DLS1(config)#vlan 434
DLS1(config-vlan)#state suspend
```

Figura 23 Suspensión de la VLAN 434

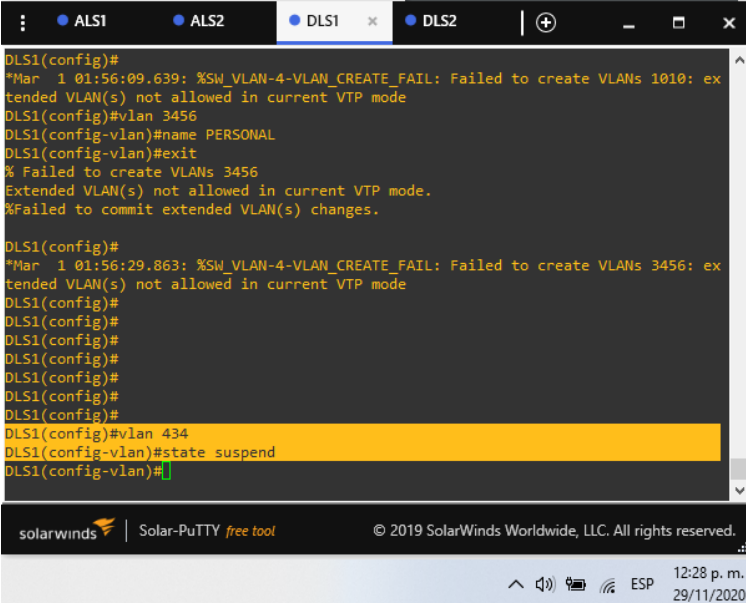

```
DLS1(config)#
*Mar 1 01:56:09.639: %SW_VLAN-4-VLAN_CREATE_FAIL: Failed to create VLANs 1010: extended VLAN(s) not allowed in current VTP mode
DLS1(config)#vlan 3456
DLS1(config-vlan)#name PERSONAL
DLS1(config-vlan)#exit
% Failed to create VLANs 3456
Extended VLAN(s) not allowed in current VTP mode.
%Failed to commit extended VLAN(s) changes.

DLS1(config)#
*Mar 1 01:56:29.863: %SW_VLAN-4-VLAN_CREATE_FAIL: Failed to create VLANs 3456: extended VLAN(s) not allowed in current VTP mode
DLS1(config)#
DLS1(config)#
DLS1(config)#
DLS1(config)#
DLS1(config)#
DLS1(config)#
DLS1(config)#
DLS1(config)#
DLS1(config)#vlan 434
DLS1(config-vlan)#state suspend
DLS1(config-vlan)#
```

- g. Configurar DLS2 en modo VTP transparente VTP utilizando VTP versión 2, y configurar en DLS2 las mismas VLAN que en DLS1.

```
DLS2(config)#vtp version 2
DLS2(config)#vtp mode transparent
Setting device to VTP TRANSPARENT mode.
DLS2(config)#vlan 500
DLS2(config-vlan)#name NATIVA
DLS2(config-vlan)#exit
DLS2(config)#vlan 12
DLS2(config-vlan)#name ADMON
DLS2(config-vlan)#exit
DLS2(config)#vlan 234
DLS2(config-vlan)#name CLIENTES
DLS2(config-vlan)#exit
DLS2(config)#vlan 1111
DLS2(config-vlan)#name MULTIMEDIA
```

```

DLS2(config-vlan)#exit
DLS2(config)#vlan 434
DLS2(config-vlan)#name PROVEEDORES
DLS2(config-vlan)#exit
DLS2(config)#vlan 123
DLS2(config-vlan)#name SEGUROS
DLS2(config-vlan)#exit
DLS2(config)#vlan 1010
DLS2(config-vlan)#name VENTAS
DLS2(config-vlan)#exit
DLS2(config)#vlan 3456
DLS2(config-vlan)#name PERSONAL
DLS2(config-vlan)#exit
DLS2(config)#

```

Figura 24 Configuración VTP transparente y VLAN en DLS2

```

*Mar 1 01:31:51.095: %SYS-5-CONFIG_I: Configured from console by console
DLS2#
DLS2#
DLS2#
DLS2#conf t
Enter configuration commands, one per line. End with CNTL/Z.
DLS2(config)#
DLS2(config)#
DLS2(config)#vtp version 2
DLS2(config)#vtp mode transparent
Setting device to VTP TRANSPARENT mode.
DLS2(config)#vlan 500
DLS2(config-vlan)#name NATIVA
DLS2(config-vlan)#exit
DLS2(config)#vlan 12
DLS2(config-vlan)#name ADMON
DLS2(config-vlan)#exit
DLS2(config)#vlan 234
DLS2(config-vlan)#name CLIENTES
DLS2(config-vlan)#exit
DLS2(config)#vlan 1111
DLS2(config-vlan)#name MULTIMEDIA
DLS2(config-vlan)#exit

```

h. Suspend VLAN 434 en DLS2.

```

DLS2(config)#vlan 434
DLS2(config-vlan)#state suspend

```

- i. En DLS2, crear VLAN 567 con el nombre de PRODUCCION. La VLAN de PRODUCCION no podrá estar disponible en cualquier otro Switch de la red.

```
DLS2(config)#vlan 567
DLS2(config-vlan)#name PRODUCCION
DLS2(config-vlan)#EXIT
```

- j. Configurar DLS1 como Spanning tree root para las VLAN 1, 12, 434, 500, 1010, 1111 y 3456 y como raíz secundaria para las VLAN 123 y 234.

```
DLS1(config)#spanning-tree vlan 1 root primary
% This switch is already the root of VLAN1 spanning tree
VLAN 1 bridge priority set to 8192
VLAN 1 bridge max aging time unchanged at 20
VLAN 1 bridge hello time unchanged at 2
VLAN 1 bridge forward delay unchanged at 15
DLS1(config)#spanning-tree vlan 12 root primary
VLAN 12 bridge priority set to 8192
VLAN 12 bridge max aging time unchanged at 20
VLAN 12 bridge hello time unchanged at 2
VLAN 12 bridge forward delay unchanged at 15
DLS1(config)#spanning-tree vlan 434 root primary
VLAN 434 bridge priority set to 8192
VLAN 434 bridge max aging time unchanged at 20
VLAN 434 bridge hello time unchanged at 2
VLAN 434 bridge forward delay unchanged at 15
DLS1(config)#spanning-tree vlan 500 root primary
VLAN 500 bridge priority set to 8192
VLAN 500 bridge max aging time unchanged at 20
VLAN 500 bridge hello time unchanged at 2
VLAN 500 bridge forward delay unchanged at 15
DLS1(config)#spanning-tree vlan 1010 root primary
VLAN 1010 bridge priority set to 8192
VLAN 1010 bridge max aging time unchanged at 20
VLAN 1010 bridge hello time unchanged at 2
VLAN 1010 bridge forward delay unchanged at 15
DLS1(config)#spanning-tree vlan 1111 root primary
VLAN 1111 bridge priority set to 8192
VLAN 1111 bridge max aging time unchanged at 20
VLAN 1111 bridge hello time unchanged at 2
VLAN 1111 bridge forward delay unchanged at 15
DLS1(config)#spanning-tree vlan 3456 root primary
VLAN 3456 bridge priority set to 8192
VLAN 3456 bridge max aging time unchanged at 20
```

```

VLAN 3456 bridge hello time unchanged at 2
VLAN 3456 bridge forward delay unchanged at 15
DLS1(config)#spanning-tree vlan 123 root secondary
VLAN 123 bridge priority set to 16384
VLAN 123 bridge max aging time unchanged at 20
VLAN 123 bridge hello time unchanged at 2
VLAN 123 bridge forward delay unchanged at 15
DLS1(config)#spanning-tree vlan 234 root secondary
VLAN 234 bridge priority set to 16384
VLAN 234 bridge max aging time unchanged at 20
VLAN 234 bridge hello time unchanged at 2
VLAN 234 bridge forward delay unchanged at 15
DLS1(config)#

```

Figura 25 Configuración VLAN primarias y secundarias en DLS1

```

DLS1(config)#spanning-tree vlan 1 root primary
% This switch is already the root of VLAN1 spanning tree
: VLAN 1 bridge priority set to 8192
: VLAN 1 bridge max aging time unchanged at 20
: VLAN 1 bridge hello time unchanged at 2
: VLAN 1 bridge forward delay unchanged at 15
DLS1(config)#spanning-tree vlan 12 root primary
VLAN 12 bridge priority set to 8192
: VLAN 12 bridge max aging time unchanged at 20
: VLAN 12 bridge hello time unchanged at 2
: VLAN 12 bridge forward delay unchanged at 15
DLS1(config)#spanning-tree vlan 434 root primary
VLAN 434 bridge priority set to 8192
VLAN 434 bridge max aging time unchanged at 20
VLAN 434 bridge hello time unchanged at 2
VLAN 434 bridge forward delay unchanged at 15
DLS1(config)#spanning-tree vlan 500 root primary
VLAN 500 bridge priority set to 8192
VLAN 500 bridge max aging time unchanged at 20
VLAN 500 bridge hello time unchanged at 2
VLAN 500 bridge forward delay unchanged at 15
DLS1(config)#spanning-tree vlan 1010 root primary
VLAN 1010 bridge priority set to 8192

```

- k. Configurar DLS2 como Spanning tree root para las VLAN 123 y 234 y como una raíz secundaria para las VLAN 12, 434, 500, 1010, 1111 y 3456.

```

DLS2(config)#spanning-tree vlan 123 root primary
VLAN 123 bridge priority set to 8192
VLAN 123 bridge max aging time unchanged at 20
VLAN 123 bridge hello time unchanged at 2
VLAN 123 bridge forward delay unchanged at 15
DLS2(config)#spanning-tree vlan 234 root primary

```

```

VLAN 234 bridge priority set to 8192
VLAN 234 bridge max aging time unchanged at 20
VLAN 234 bridge hello time unchanged at 2
VLAN 234 bridge forward delay unchanged at 15
DLS2(config)#spanning-tree vlan 12 root secondary
VLAN 12 bridge priority set to 16384
VLAN 12 bridge max aging time unchanged at 20
VLAN 12 bridge hello time unchanged at 2
VLAN 12 bridge forward delay unchanged at 15
DLS2(config)#spanning-tree vlan 434 root secondary
VLAN 434 bridge priority set to 16384
VLAN 434 bridge max aging time unchanged at 20
VLAN 434 bridge hello time unchanged at 2
VLAN 434 bridge forward delay unchanged at 15
DLS2(config)#spanning-tree vlan 500 root secondary
VLAN 500 bridge priority set to 16384
VLAN 500 bridge max aging time unchanged at 20
VLAN 500 bridge hello time unchanged at 2
VLAN 500 bridge forward delay unchanged at 15
DLS2(config)#spanning-tree vlan 1010 root secondary
VLAN 1010 bridge priority set to 16384
VLAN 1010 bridge max aging time unchanged at 20
VLAN 1010 bridge hello time unchanged at 2
VLAN 1010 bridge forward delay unchanged at 15
DLS2(config)#spanning-tree vlan 1111 root secondary
VLAN 1111 bridge priority set to 16384
VLAN 1111 bridge max aging time unchanged at 20
VLAN 1111 bridge hello time unchanged at 2
VLAN 1111 bridge forward delay unchanged at 15
DLS2(config)#spanning-tree vlan 3456 root secondary
VLAN 3456 bridge priority set to 16384
VLAN 3456 bridge max aging time unchanged at 20
VLAN 3456 bridge hello time unchanged at 2
VLAN 3456 bridge forward delay unchanged at 15
DLS2(config)#

```

- I. Configurar todos los puertos como troncales de tal forma que solamente las VLAN que se han creado se les permitirá circular a través de éstos puertos.

```

DLS1(config)#int ran f1/7 - 12
DLS1(config-if-range)#switchport trunk allowed vlan all

```

```

DLS2(config)#int ran f1/7 - 12
DLS2(config-if-range)#switchport trunk allowed vlan all

```

```

ALS1(config)#int ran f1/7 - 10
ALS1(config-if-range)#switchport trunk allowed vlan all

```

```

ALS2(config)#int ran f1/7 - 10
ALS2(config-if-range)#switchport trunk allowed vlan all

```

- m. Configurar las siguientes interfaces como puertos de acceso, asignados a las VLAN de la siguiente manera:

Tabla 5 Interfaces puertos de acceso

Interfaz	DLS1	DLS2	ALS1	ALS2
Interfaz Fa0/6	3456	12, 1010	123, 1010	234
Interfaz Fa0/15	1111	1111	1111	1111
Interfaces F0 /16-18		567		

```

DLS1(config)#int f1/6
DLS1(config-if)#switchport mode access
DLS1(config-if)#sw access vlan 3456
% Access VLAN does not exist. Creating vlan 3456
DLS1(config-if)#
*Mar  1 02:25:53.455: %PM-2-VLAN_ADD: Failed to add VLAN 3456 - VTP
error.
DLS1(config-if)#int f1/15
DLS1(config-if)#switchport mode access
DLS1(config-if)#sw access vlan 1111
% Access VLAN does not exist. Creating vlan 1111
DLS1(config-if)#
*Mar  1 02:26:42.095: %PM-2-VLAN_ADD: Failed to add VLAN 1111 - VTP
error.
DLS1(config-if)#

```

```

DLS2(config)#int f1/6
DLS2(config-if)#switchport mode access
DLS2(config-if)#sw access vlan 12
DLS2(config-if)#int f1/6
DLS2(config-if)#switchport mode access
DLS2(config-if)#sw access vlan 1010
DLS2(config-if)#int f1/15

```

```
DLS2(config-if)#switchport mode access
DLS2(config-if)#sw access vlan 1111
DLS2(config-if)#int range f1/16 - 18
      ^
```

% Invalid input detected at '^' marker.

```
ALS1#conf t
Enter configuration commands, one per line. End with CNTL/Z.
ALS1(config)#int f1/6
ALS1(config-if)#switchport mode access
ALS1(config-if)#sw access vlan 123
ALS1(config-if)#int f1/6
ALS1(config-if)#switchport mode access
ALS1(config-if)#sw access vlan 1010
ALS1(config-if)#int f1/15
ALS1(config-if)#switchport mode access
ALS1(config-if)#sw access vlan 1111
ALS1(config-if)#
```

```
ALS2(config)#int f1/6
ALS2(config-if)#switchport mode access
ALS2(config-if)#sw access vlan 234
ALS2(config-if)#int f1/15
ALS2(config-if)#switchport mode access
ALS2(config-if)#sw access vlan 1111
ALS2(config-if)#
ALS2(config-if)#
```

Figura 26 Configuración interfaces en DLS2

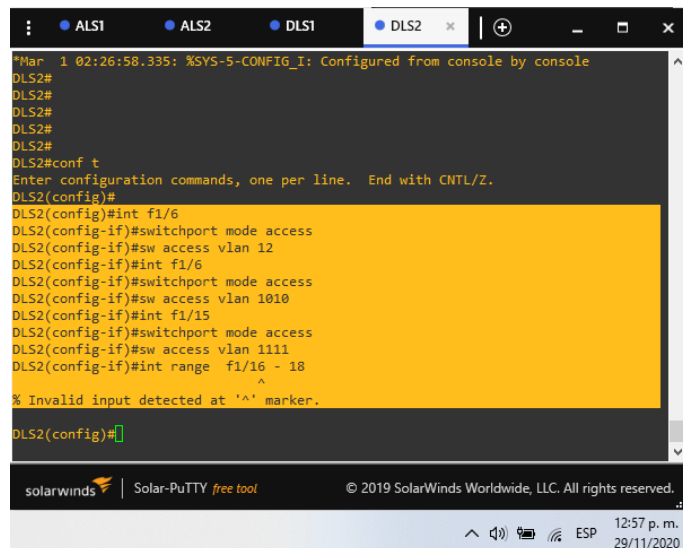

```
*Mar 1 02:26:58.335: %SYS-5-CONFIG_I: Configured from console by console
DLS2#
DLS2#
DLS2#
DLS2#
DLS2#
DLS2#conf t
Enter configuration commands, one per line. End with CNTL/Z.
DLS2(config)#
DLS2(config)#int f1/6
DLS2(config-if)#switchport mode access
DLS2(config-if)#sw access vlan 12
DLS2(config-if)#int f1/6
DLS2(config-if)#switchport mode access
DLS2(config-if)#sw access vlan 1010
DLS2(config-if)#int f1/15
DLS2(config-if)#switchport mode access
DLS2(config-if)#sw access vlan 1111
DLS2(config-if)#int range f1/16 - 18
      ^
% Invalid input detected at '^' marker.
DLS2(config)#
```

Parte 2: conectividad de red de prueba y las opciones configuradas.

- Verificar la existencia de las VLAN correctas en todos los switches y la asignación de puertos troncales y de acceso

Aplicando el comando show vlan-sw se obtiene la tabla correspondiente

Figura 27 Verificaciones de la existencia de las VLAN

```

DLS1#show vlan-sw
VLAN Name                Status    Ports
-----
1    default                 active    Fa1/0, Fa1/1, Fa1/2, Fa1/3
                                           Fa1/4, Fa1/5, Fa1/9, Fa1/10
                                           Fa1/13, Fa1/14, Po1
12   ADMON                   active
123  SEGUROS                  active
234  CLIENTES                 active
434  PROVEEDORES              suspended
500  NATIVA                   active
1002 fddi-default             act/unsup
1003 token-ring-default      act/unsup
1004 fddinet-default        act/unsup
1005 trnet-default         act/unsup

VLAN Type SAID      MTU   Parent RingNo BridgeNo Stp    BrgdMode Trans1 Trans2
-----
1    enet  100001  1500  -     -     -     -     -     1002  1003
12   enet  100012  1500  -     -     -     -     -     0     0
123  enet  100123  1500  -     -     -     -     -     0     0
234  enet  100234  1500  -     -     -     -     -     0     0
434  enet  100434  1500  -     -     -     -     -     0     0

VLAN Type SAID      MTU   Parent RingNo BridgeNo Stp    BrgdMode Trans1 Trans2
-----
500  enet  100500  1500  -     -     -     -     -     0     0
1002 fddi  101002  1500  -     -     -     -     -     1     1003
  
```

```

DLS2#show vlan-sw
VLAN Name                Status    Ports
-----
1    default                 active    Fa1/0, Fa1/1, Fa1/2, Fa1/3
                                           Fa1/4, Fa1/5, Fa1/9, Fa1/10
                                           Fa1/13, Fa1/14, Po1
12   ADMON                   active
123  SEGUROS                  active
234  CLIENTES                 active
434  PROVEEDORES              suspended
500  NATIVA                   active
567  PRODUCCION               active
1002 fddi-default             act/unsup
1003 trcrf-default          act/unsup
1004 fddinet-default        act/unsup
1005 trbrf-default         act/unsup
1010 VENTAS                   active    Fa1/6
1111 MULTIMEDIA            active    Fa1/15
3456 PERSONAL              active

VLAN Type SAID      MTU   Parent RingNo BridgeNo Stp    BrgdMode Trans1 Trans2
-----
1    enet  100001  1500  -     -     -     -     -     1002  1003

VLAN Type SAID      MTU   Parent RingNo BridgeNo Stp    BrgdMode Trans1 Trans2
-----
12   enet  100012  1500  -     -     -     -     -     0     0
123  enet  100123  1500  -     -     -     -     -     0     0
  
```

```

ALS1#
ALS1#show vlan-sw
VLAN Name                Status    Ports
-----
1    default                active   Fa1/0, Fa1/1, Fa1/2, Fa1/3
    Fa1/4, Fa1/5, Fa1/9, Fa1/10
    Fa1/11, Fa1/12, Fa1/13, Fa1/14
    Po1
1002 fddi-default          act/unsup
1003 token-ring-default    act/unsup
1004 fddinet-default      act/unsup
1005 trnet-default        act/unsup

VLAN Type  SAID      MTU    Parent RingNo BridgeNo  Stp  BrdgMode Trans1 Trans2
-----
1    enet    100001   1500   -     -     -     -     -     1002  1003
1002 fddi    101002   1500   -     -     -     -     -     1     1003
1003 tr     101003   1500   1005  0     -     -     srb    1     1002
1004 fdnet 101004   1500   -     -     1     -     ibm    -     0     0
1005 trnet 101005   1500   -     -     1     -     ibm    -     0     0
ALS1#

```

```

ALS2#
ALS2#show vlan-sw
VLAN Name                Status    Ports
-----
1    default                active   Fa1/0, Fa1/1, Fa1/2, Fa1/3
    Fa1/4, Fa1/5, Fa1/9, Fa1/10
    Fa1/11, Fa1/12, Fa1/13, Fa1/14
    Po1
1002 fddi-default          act/unsup
1003 token-ring-default    act/unsup
1004 fddinet-default      act/unsup
1005 trnet-default        act/unsup

VLAN Type  SAID      MTU    Parent RingNo BridgeNo  Stp  BrdgMode Trans1 Trans2
-----
1    enet    100001   1500   -     -     -     -     -     1002  1003
1002 fddi    101002   1500   -     -     -     -     -     1     1003
1003 tr     101003   1500   1005  0     -     -     srb    1     1002
1004 fdnet 101004   1500   -     -     1     -     ibm    -     0     0
1005 trnet 101005   1500   -     -     1     -     ibm    -     0     0
ALS2#

```

b. Verificar que el EtherChannel entre DLS1 y ALS1 está configurado correctamente

Por medio del comando mostrado a continuación se muestra como los puertos f1/7 y f1/8 están conectados mediante esta configuración los cuales corresponden a la conexión entre DLS1 y ALS1

DLS1#show etherchannel port-channel

Figura 28 Verificación conexión entre DLS1 y ALS1 por EtherChannel

```
Port-channel: Po1
-----
Age of the Port-channel = 00d:01h:46m:13s
Logical slot/port = 8/0      Number of ports = 2
GC = 0x00010001      HotStandBy port = null
Port state = Port-channel Ag-Inuse

Ports in the Port-channel:
-----
Index  Port    EC state
-----
0      Fa1/7   on
1      Fa1/8   on

Time since last port bundled: 00d:01h:46m:13s  Fa1/8

Group: 4
-----
Port-channels in the group:
```

- c. Verificar la configuración de Spanning tree entre DLS1 o DLS2 para cada VLAN.

Por medio del comando mostrado a continuación se observa la conexión por el puerto correspondiente entre los dispositivos DLS1 y DLS2 en cada VLAN

DLS1#show spanning-tree

Figura 29 Verificación configuración Spanning tree entre DLS1 y DLS2

```
DLS2#show spanning-tree

VLAN1 is executing the ieee compatible Spanning Tree protocol
Bridge Identifier has priority 32768, address c202.30dc.0000
Configured hello time 2, max age 20, forward delay 15
We are the root of the spanning tree
Topology change flag not set, detected flag not set
Number of topology changes 16 last change occurred 00:22:07 ago
from Port-channel1
Times: hold 1, topology change 35, notification 2
hello 2, max age 20, forward delay 15
Timers: hello 1, topology change 0, notification 0, aging 300

Port 321 (Port-channel1) of VLAN1 is forwarding
Port path cost 12, Port priority 128, Port Identifier 129.65.
Designated root has priority 32768, address c202.30dc.0000
Designated bridge has priority 32768, address c202.30dc.0000
Designated port id is 129.65, designated path cost 0
Timers: message age 0, forward delay 0, hold 0
Number of transitions to forwarding state: 2
BPDU: sent 3248, received 194

VLAN1010 is executing the ieee compatible Spanning Tree protocol
Bridge Identifier has priority 16384, address c202.30dc.0001
Configured hello time 2, max age 20, forward delay 15
We are the root of the spanning tree
Topology change flag not set, detected flag not set
Number of topology changes 1 last change occurred 00:26:35 ago
from FastEthernet1/6
Times: hold 1, topology change 35, notification 2
hello 2, max age 20, forward delay 15
Timers: hello 1, topology change 0, notification 0, aging 300

Port 47 (FastEthernet1/6) of VLAN1010 is forwarding
Port path cost 19, Port priority 128, Port Identifier 128.47.
```

CONCLUSIONES

A través de los comandos IOS de configuración avanzada en Router con direccionamiento IPv4 e IPv6 para protocolos de enrutamiento como RIPng, OSPFv3, EIGRP y BGP, se logra diseñar e implementar soluciones de red escalables, haciendo uso adecuado de los principios de enrutamiento y conmutación de paquetes en ambientes LAN y WAN

Mediante las herramientas de simulación se logra analizar el comportamiento de los protocolos y de esta manera evaluar el desempeño de los dispositivos conectados en una red. Para esto es necesario hacer uso de los comandos de configuración y administración de dispositivos avanzado que ofrecen los protocolos creados por CISCO.

La configuración de plataformas de conmutación permite comprender el modo de operación de las subredes y los beneficios de administrarlos de manera adecuada. Las VLAN permiten administrar múltiples escenarios al interior de una red jerárquica convergente.

Por medio de la aplicación de los protocolos ofrecidos por CISCO, la correcta configuración de los dispositivos y el uso adecuado de los comandos en cada una de las interfaces y niveles de la red, se pueden resolver conflictos de configuración y conectividad en contextos de redes LAN y WAN.

BIBLIOGRAFIA

Teare, D., Vachon B., Graziani, R. (2015). CISCO Press (Ed). Basic Network and Routing Concepts. Implementing Cisco IP Routing (ROUTE) Foundation Learning Guide CCNP ROUTE 300-101. Recuperado de <https://1drv.ms/b/s!AmlJYei-NT1IlnMfy2rhPZHwEoWx>

Teare, D., Vachon B., Graziani, R. (2015). CISCO Press (Ed). EIGRP Implementation. Implementing Cisco IP Routing (ROUTE) Foundation Learning Guide CCNP ROUTE 300-101. Recuperado de <https://1drv.ms/b/s!AmlJYei-NT1IlnMfy2rhPZHwEoWx>

Teare, D., Vachon B., Graziani, R. (2015). CISCO Press (Ed). OSPF Implementation. Implementing Cisco IP Routing (ROUTE) Foundation Learning Guide CCNP ROUTE 300-101. Recuperado de <https://1drv.ms/b/s!AmlJYei-NT1IlnMfy2rhPZHwEoWx>

Teare, D., Vachon B., Graziani, R. (2015). CISCO Press (Ed). Manipulating Routing Updates. Implementing Cisco IP Routing (ROUTE) Foundation Learning Guide CCNP ROUTE 300-101. Recuperado de <https://1drv.ms/b/s!AmlJYei-NT1IlnMfy2rhPZHwEoWx>

Teare, D., Vachon B., Graziani, R. (2015). CISCO Press (Ed). Path Control Implementation. Implementing Cisco IP Routing (ROUTE) Foundation Learning Guide CCNP ROUTE 300-101. Recuperado de <https://1drv.ms/b/s!AmlJYei-NT1IlnMfy2rhPZHwEoWx>

Teare, D., Vachon B., Graziani, R. (2015). CISCO Press (Ed). Enterprise Internet Connectivity. Implementing Cisco IP Routing (ROUTE) Foundation Learning Guide CCNP ROUTE 300-101. Recuperado de <https://1drv.ms/b/s!AmlJYei-NT1IlnMfy2rhPZHwEoWx>

Teare, D., Vachon B., Graziani, R. (2015). CISCO Press (Ed). Implementing a Border Gateway Protocol (BGP). Implementing Cisco IP Routing (ROUTE) Foundation Learning Guide CCNP ROUTE 300-101. Recuperado de <https://1drv.ms/b/s!AmlJYei-NT1IlnMfy2rhPZHwEoWx>

Teare, D., Vachon B., Graziani, R. (2015). CISCO Press (Ed). Routers and Routing Protocol Hardening. Implementing Cisco IP Routing (ROUTE) Foundation Learning Guide CCNP ROUTE 300-101. Recuperado de <https://1drv.ms/b/s!AmlJYei-NT1IlnMfy2rhPZHwEoWx>

Froom, R., Frahim, E. (2015). CISCO Press (Ed). Switch Fundamentals Review. Implementing Cisco IP Switched Networks (SWITCH) Foundation Learning Guide

CCNP SWITCH 300-115. Recuperado de <https://1drv.ms/b/s!AmIJYei-NT1InWR0hoMxgBNv1CJ>

Froom, R., Frahim, E. (2015). CISCO Press (Ed). Network Design Fundamentals. Implementing Cisco IP Switched Networks (SWITCH) Foundation Learning Guide CCNP SWITCH 300-115. Recuperado de <https://1drv.ms/b/s!AmIJYei-NT1InWR0hoMxgBNv1CJ>

Froom, R., Frahim, E. (2015). CISCO Press (Ed). Campus Network Architecture. Implementing Cisco IP Switched Networks (SWITCH) Foundation Learning Guide CCNP SWITCH 300-115. Recuperado de <https://1drv.ms/b/s!AmIJYei-NT1InWR0hoMxgBNv1CJ>

Froom, R., Frahim, E. (2015). CISCO Press (Ed). Spanning Tree Implementation. Implementing Cisco IP Switched Networks (SWITCH) Foundation Learning Guide CCNP SWITCH 300-115. Recuperado de <https://1drv.ms/b/s!AmIJYei-NT1InWR0hoMxgBNv1CJ>

Froom, R., Frahim, E. (2015). CISCO Press (Ed). Inter VLAN Routing. Implementing Cisco IP Switched Networks (SWITCH) Foundation Learning Guide CCNP SWITCH 300-115. Recuperado de <https://1drv.ms/b/s!AmIJYei-NT1InWR0hoMxgBNv1CJ>

Froom, R., Frahim, E. (2015). CISCO Press (Ed). First Hop Redundancy Protocols. Implementing Cisco IP Switched Networks (SWITCH) Foundation Learning Guide CCNP SWITCH 300-115. Recuperado de <https://1drv.ms/b/s!AmIJYei-NT1InWR0hoMxgBNv1CJ>

Froom, R., Frahim, E. (2015). CISCO Press (Ed). Network Management. Implementing Cisco IP Switched Networks (SWITCH) Foundation Learning Guide CCNP SWITCH 300-115. Recuperado de <https://1drv.ms/b/s!AmIJYei-NT1InWR0hoMxgBNv1CJ>

Froom, R., Frahim, E. (2015). CISCO Press (Ed). Switching Features and Technologies. Implementing Cisco IP Switched Networks (SWITCH) Foundation Learning Guide CCNP SWITCH 300-115. Recuperado de <https://1drv.ms/b/s!AmIJYei-NT1InWR0hoMxgBNv1CJ>

Froom, R., Frahim, E. (2015). CISCO Press (Ed). High Availability. Implementing Cisco IP Switched Networks (SWITCH) Foundation Learning Guide CCNP SWITCH 300-115. Recuperado de <https://1drv.ms/b/s!AmIJYei-NT1InWR0hoMxgBNv1CJ>

Froom, R., Frahim, E. (2015). CISCO Press (Ed). EIGRP Implementation. Implementing Cisco IP Switched Networks (SWITCH) Foundation Learning Guide CCNP SWITCH 300-115. Recuperado de <https://1drv.ms/b/s!AmIJYei-NT1InWR0hoMxgBNv1CJ>