

SOLUCIÓN CASOS DE ESTUDIO CCNA 1 Y CCNA 2
CURSO DE PROFUNDIZACIÓN CISCO

ALEXANDER MAYORCA
CODIGO 79418031

UNIVERSIDAD NACIONAL ABIERTA Y A DISTANCIA - UNAD
ESCUELA DE CIENCIAS BÁSICAS, TECNOLOGÍA E INGENIERÍA
INGENIERÍA DE SISTEMAS
CUBARÁ, Junio de 2013

SOLUCIÓN CASOS DE ESTUDIO CCNA 1 Y CCNA 2
CURSO DE PROFUNDIZACIÓN CISCO

ALEXANDER MAYORCA
CODIGO 79418031

Monografía Presentada como requisito
Para optar al título de Ingeniero de Sistemas

TUTOR
ING. JUAN CARLOS VESGA

UNIVERSIDAD NACIONAL ABIERTA Y A DISTANCIA - UNAD
ESCUELA DE CIENCIAS BÁSICAS, TECNOLOGÍA E INGENIERÍA
INGENIERÍA DE SISTEMAS
CUBARÁ, Junio de 2013

DEDICATORIA

Al Señor de los Milagros y la Virgen Santísima por permitirme la sabiduría para culminar con éxito mis estudios, a mi esposa y mis hijos por comprenderme en todos aquellos momentos en los cuales deje de compartir en familia, por cumplir con las exigencias del estudio de manera responsable y dedicada; gracias por brindarme su apoyo incondicional y alentarme en los momentos difíciles.

A mis compañeros por acompañarme en las alegrías y desaciertos de este sueño de ser profesional llamado Ingeniero de Sistemas.

ALEXANDER MAYORCA

Contenido

OBJETIVOS	8
GENERAL	8
ESPECÍFICOS.....	8
JUSTIFICACIÓN	10
SOLUCIÓN CASO DE ESTUDIO: CCNA 1 EXPLORATION	12
POR CADA LAN	13
POR CADA CONEXIÓN SERIAL	13
EN CADA ROUTER CONFIGURAR:	13
<i>INTERFAZ DE CONEXIÓN DE RED LAN:</i>	15
<i>CONFIGURACIÓN ROUTER BUCARAMANGA</i>	16
<i>Bucaramanga#show running-config</i>	16
<i>CONFIGURACIÓN ROUTER BOGOTA</i>	19
<i>Bogota#show running-config</i>	19
<i>CONFIGURACIÓN ROUTER BARRANQUILLA</i>	22
<i>Barranquilla#show running-config</i>	22
<i>CONFIGURACIÓN ROUTER MEDELLÍN</i>	25
<i>Medellin#show running-config</i>	25
<i>CONFIGURACIÓN ROUTER CALI</i>	28
<i>Cali#show running-config</i>	28
<i>PRUEBAS DE CONEXIÓN</i>	31
SOLUCIÓN CASO DE ESTUDIO CCNA 2 EXPLORATION	34
ENUNCIADO PRINCIPAL DEL CASO DE ESTUDIO	34
DISEÑO Y DOCUMENTACIÓN DE UN ESQUEMA DE DIRECCIONAMIENTO.....	35
APLICACIÓN DE UNA CONFIGURACIÓN BÁSICA.	37
CONFIGURAR EL ENRUTAMIENTO OSPF	38
AJUSTE REFINADO DE OSPF	39
CONFIGURACIÓN DE UN LOOPBACK	41
VISUALIZACIÓN DE LAS ACTUALIZACIONES OSPF.....	43
CONFIGURACION FINAL R1	44
<i>R1#show ip ospf interface</i>	48
<i>R1#show ip ospf neighbor</i>	49
<i>R1#show ip route</i>	49

<i>R1#show ip protocols</i>	50
CONFIGURACION FINAL R2.....	51
<i>R2#show running-config</i>	51
<i>R2#show ip route</i>	55
<i>R2#show ip ospf interface</i>	56
<i>R2#show ip ospf neighbor</i>	58
<i>R2#show ip protocols</i>	58
CONFIGURACION FINAL R3.....	59
<i>R3#show running-config</i>	59
<i>R3#show ip route</i>	62
<i>R3#show ip ospf interface</i>	63
<i>R3#show ip ospf neighbor</i>	65
<i>R3#show ip protocols</i>	65
CONFIGURACION FINAL R4.....	66
<i>R4#show running-config</i>	66
<i>R4#show ip route</i>	69
<i>R4#show ip protocols</i>	70
<i>R4#show ip ospf interface</i>	71
<i>R4#show ip ospf neighbor</i>	74
CONFIGURACION FINAL R5.....	74
<i>R5#show running-config</i>	74
<i>R5#show ip route</i>	77
<i>R5#show ip protocols</i>	78
<i>R5#show ip ospf interface</i>	79
<i>R5#show ip ospf neighbor</i>	81
CONFIGURACION FINAL R6.....	81
<i>R6#show running-config</i>	81
<i>R6#show ip route</i>	85
<i>R6#show ip protocols</i>	86
<i>R6#show ip ospf interface</i>	87
<i>R6#show ip ospf neighbor</i>	89
CONCLUSIONES	91
BIBLIOGRAFIA	92

LISTA DE ILUSTRACIONES

Ilustración 1. Topología de red WAN Comerciantes S.A.....	12
Ilustración 2. Diagrama de topología con Enrutamiento y Direccionamiento	31
Ilustración 3. Prueba de Ping Router Bucaramanga exitosa	32
Ilustración 4. Prueba de Ping Router Bogotá exitosa	32
Ilustración 5. Prueba de Ping Router Barranquilla exitosa	33
Ilustración 6. Prueba Tracer Route desde router Bucaramanga	33
Ilustración 7. Diagrama de topología Caso de estudio 2	34
Ilustración 8. Ejemplo de configuración básica.....	38
Ilustración 9. Configuración de enrutamiento OSPF	39
Ilustración 10. R2 será el DR.....	40
Ilustración 11. R4 será el BDR	40
Ilustración 12. R3 reconoce sus vecinos DR y BDR.....	41
Ilustración 13. Configuración Loopback, ruta por defecto y actualización OSPF	42
Ilustración 14: Topología caso de estudio 2	43
Ilustración 15. Actualizaciones OSPF	44

LISTA DE TABLAS

Tabla 2. Direccionamiento de red LAN.....	14
Tabla 3. Direccionamiento de red WAN	15
Tabla 4.interfaz de conexión de los Routers	15
Tabla 5. Interfaz de conexión de red LAN Bucaramanga.....	15
Tabla 6. Interfaz de conexión de red LAN Bogotá.....	15
Tabla 7. Interfaz de conexión de la red LAN Barranquilla	15
Tabla 8. Interfaz de conexión de la red LAN Medellín.....	16
Tabla 9. Interfaz de conexión de la red LAN Cali	16
Tabla 10. Requisitos de direccionamiento.....	35
Tabla 11. Esquema de direccionamiento	35
Tabla 12. VLSM para esquema de direccionamiento.....	37
Tabla 13. Configuraciones Básicas a los routers	38

OBJETIVOS

GENERAL

- Diseñar las redes propuestas en los casos de estudio CCNA1 y CCNA2, atendiendo para ello las topologías y direccionamiento, realizando las simulaciones con el software Packet Tracer versión 5.3.3.

ESPECÍFICOS

- Diseñar e implementar una red WAN conforme a los datos suministrados por la empresa COMERCIANTE S.A.
- Realizar la configuración y funcionamiento de la red WAN virtual por medio de la herramienta de diseño Packet tracer.
- Verificar el correcto funcionamiento de cada uno de los componentes de la red realizando pruebas de conexión en cada dispositivo.
- Realizar las tablas de información de la configuración de los Router y Switch utilizados en el diseño de la red.
- Diseñar y documentar un esquema de direccionamiento según los requisitos.
- Aplicar una configuración básica a los dispositivos.
- Configurar una prioridad de routers y RID.
- Configurar el enrutamiento OSPF
- Desactivación de las actualizaciones de enrutamiento en las interfaces

adecuadas.

- Verificación de la completa conectividad entre todos los dispositivos de la topología.
- Emplear el comando `default-information originate` para configurar y propagar una ruta por defecto en OSPF.

JUSTIFICACIÓN

La academia Cisco y en particular el curso CCNA1 Exploration, nos permite conocer aspectos fundamentales del networking, brindando aptitudes y conocimiento en detalle de los principales modelos en el diseño, planeación e implementación de redes como son las capas OSI y TCP-IP, con el único propósito de desarrollar habilidades prácticas, analíticas y conceptuales, con el fin de mostrar cómo se comunican los diferentes dispositivos involucrados en una red.

Para dar cumplimiento con los objetivos de aprendizaje y aplicar lo desarrollado durante las secciones de prácticas, utilizando para ello las temáticas vistas durante el transcurso de los capítulos y adquiriendo destrezas apoyado con la herramienta Packet Tracer 5.3.3, un software que admite una amplia gama de simulaciones físicas y lógicas permitiendo la creación de experimentos propios y situaciones de red; de esta manera se explora la interacción de protocolos, servicios, aplicaciones y funcionalidades como la Ethernet con su tecnología full-dúplex; planificando e identificando los diferentes cables necesarios para lograr conexiones LAN y WAN exitosas, conectando y configurando los diferentes dispositivos como equipos, routers, switches, etc. y realizando finalmente las pruebas de conexión.

El curso CCNA2 Exploration, nos muestra la actualidad de las redes teniendo un impacto significativo en el diario transcurrir de nuestras vidas, cambiando nuestra forma de vivir, trabajar y divertirnos; más exactamente aprovechar las ventajas

otorgadas por la red de redes La Internet, que nos permite comunicarnos, colaborarnos e interactuar de manera totalmente novedosa utilizando para ello la Web, la telefonía IP, la videoconferencia, los juegos interactivos, el comercio electrónico, la educación y mucho más.

Con esta monografía el autor aplicará y explicará los conceptos de los protocolos de enrutamiento de estado de enlace, conocidos también como protocolo de shortest path firsts, desarrollado entorno del algoritmo de Edsger Dijkstra, como reemplazo del protocolo de enrutamiento por vector distancia RIP, el cual permite una rápida convergencia y escalabilidad en la implementación de redes mayores.

SOLUCIÓN CASO DE ESTUDIO: CCNA 1 EXPLORATION

Una empresa denominada COMERCIANTES S.A. desea implementar una red WAN acorde con la estructura que se ilustra en la siguiente figura.



Ilustración 1. Topología de red WAN Comerciantes S.A.

La cantidad de host requeridos por cada una de las LAN es la siguiente:

Contabilidad	:	15
Mercadeo	:	10
Ventas Sucursal 1	:	30
Ventas Sucursal 2	:	40
Administrativos	:	25

Se desea establecer cada uno de los siguientes criterios:

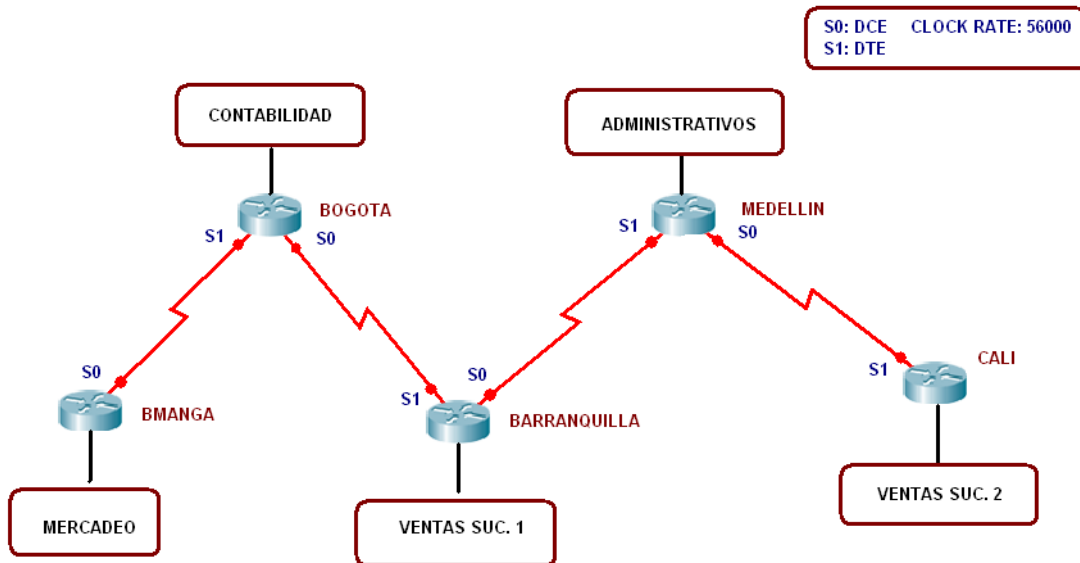
- Protocolo de enrutamiento: RIP Versión 2
- Todos los puertos seriales 0 (S0) son terminales DCE Todos los puertos seriales 1 (S1) son terminales DTE.
- Definir la tabla de direcciones IP indicando por cada subred los siguientes

elementos:

Por cada LAN

1. Dirección de Red
2. Dirección IP de Gateway
3. Dirección IP del Primer PC
4. Dirección IP del último PC
5. Dirección de Broadcast
6. Máscara de Subred

Por cada conexión serial

1. Dirección de Red
2. Dirección IP Serial 0 (Indicar a qué Router pertenece)
3. Dirección IP Serial 1 (Indicar a qué Router pertenece)
4. Dirección de Broadcast
5. Máscara de Subred

En cada Router configurar:

1. Nombre del Router (Hostname)
2. Direcciones IP de las Interfaces a utilizar
3. Por cada interface utilizada, hacer uso del comando DESCRIPTION con el fin de indicar la función que cumple cada interface. Ej. Interfaz de conexión con la red LAN Mercadeo.
4. Establecer contraseñas para: CON 0, VTY, ENABLE SECRET. Todas

con el Password: CISCO

5. Protocolo de enrutamiento a utilizar: RIP Versión 2

Se debe realizar la configuración de la misma mediante el uso de Packet Tracer, los routers deben ser de referencia 1841 y los Switches 2950. Por cada subred se deben dibujar solamente dos Host identificados con las direcciones IP correspondientes al primer y último PC acorde con la cantidad de equipos establecidos por subred.

El trabajo debe incluir toda la documentación correspondiente al diseño, copiar las configuraciones finales de cada router mediante el uso del comando Show Running-config, archivo de simulación en Packet Tracer y verificación de funcionamiento de la red mediante el uso de comandos: Ping y Traceroute.

Para cada LAN: 192.168.5.0/24

LAN	RED	MASCARA	GATEWAY	PRIMER HOST	ÚLTIMO HOST	BROADCAST
Ventas Suc. 2	192.168.5.0	255.255.255.192	192.168.5.1	192.168.5.2	192.168.5.41	192.168.5.63
Ventas Suc 1	192.168.6.0	255.255.255.192	192.168.6.1	192.168.6.2	192.168.6.31	192.168.6.63
Administrativos	192.168.7.0	255.255.255.224	192.168.7.1	192.168.7.2	192.168.7.26	192.168.7.31
Contabilidad	192.168.8.0	255.255.255.224	192.168.8.1	192.168.8.2	192.168.8.16	192.168.8.31
Mercadeo	192.168.9.0	255.255.255.240	192.168.9.1	192.168.9.2	192.168.9.11	192.168.9.15

Tabla 1. Direccionamiento de red LAN

Para cada conexión SERIAL: 172.17.1.0/24

WAN	IP SERIAL 0	IP SERIAL 1	BROADCAST	MASCARA SUBRED
Bucaramanga – Bogotá	172.17.1.1	172.17.1.2	172.17.1.3	255.255.255.252
Bogotá - Barranquilla	172.17.2.1	172.17.2.2	172.17.2.3	255.255.255.252
Barranquilla – Medellín	172.17.3.1	172.17.3.2	172.17.3.3	255.255.255.252
Medellín – Cali	172.17.4.1	172.17.4.2	172.17.4.3	255.255.255.252

Tabla 2. Direccionamiento de red WAN

Para cada ROUTER:

ROUTER	FA0/0	S 0/1/0	S 0/1/1
Bucaramanga	192.168.9.1	172.17.1.1	
Bogotá	192.168.8.1	172.17.2.1	172.17.1.2
Barranquilla	192.168.6.1	172.17.3.1	172.17.2.2
Medellín	192.168.7.1	172.17.4.1	172.17.3.2
Cali	192.168.5.1		172.17.4.2

Tabla 3.interfaz de conexión de los Routers

INTERFAZ DE CONEXIÓN DE RED LAN:

LAN MERCADEO	DIRECCIÓN IP	MASCARA	GATEWAY
Buc_mer1	192.168.9.2	255.255.255.240	192.168.9.1
Buc_mer10	192.168.9.11	255.255.255.240	192.168.9.1

Tabla 4. Interfaz de conexión de red LAN Bucaramanga

LAN CONTABILIDAD	DIRECCIÓN IP	MASCARA	GATEWAY
Bog_con1	192.168.8.2	255.255.255.224	192.168.8.1
Bog_con15	192.168.8.16	255.255.255.224	192.168.8.1

Tabla 5. Interfaz de conexión de red LAN Bogotá

LAN VENTAS SUCURSAL 1	DIRECCIÓN IP	MASCARA	GATEWAY
Bar_suc1	192.168.6.2	255.255.255.192	192.168.6.1
Bar_suc30	192.168.6.31	255.255.255.192	192.168.6.1

Tabla 6. Interfaz de conexión de la red LAN Barranquilla

LAN ADMINISTRATIVOS	DIRECCIÓN IP	MASCARA	GATEWAY
Med_adm1	192.168.7.2	255.255.255.224	192.168.7.1
Med_adm25	192.168.7.26	255.255.255.224	192.168.7.1

Tabla 7. Interfaz de conexión de la red LAN Medellín

LAN VENTAS SUCRUSAL 2	DIRECCIÓN IP	MASCARA	GATEWAY
Cal_suc1	192.168.5.2	255.255.255.192	192.168.5.1
Cal_suc40	192.168.5.41	255.255.255.192	192.168.5.1

Tabla 8. Interfaz de conexión de la red LAN Cali

CONFIGURACIÓN ROUTER BUCARAMANGA

```

Bucaramanga#show running-config
Building configuration...

Current configuration : 926 bytes

version 12.4

no service timestamps log datetime msec
no service timestamps debug datetime msec
no service password-encryption

!

hostname Bucaramanga

!

!

!

enable secret 5 $1$mERr$NJdjwh5wX8la/X8aC4RIu.

```



```
spanning-tree mode pvst
```

```
!
```

```
!
```

```
!
```

```
!
```

```
interface FastEthernet0/0
```

```
description Interfaz de conexion con la red Lan MERCADEO
```

```
ip address 192.168.9.1 255.255.255.240
```

```
duplex auto
```

```
speed auto
```

```
!
```

```
interface FastEthernet0/1
```

```
no ip address
```

```
duplex auto
```

```
speed auto
```

```
shutdown
```

```
!
```

```
interface Serial0/1/0
```

```
description Interfaz de conexion con la red WAN BOGOTA
```

```
ip address 172.17.1.1 255.255.255.252
```

```
clock rate 56000
```

```
!
```

```
interface Serial0/1/1
```

```
no ip address
shutdown
interface Vlan1
no ip address
shutdown
!
router rip
version 2
passive-interface FastEthernet0/0
network 172.17.0.0
network 192.168.9.0
!
ip classless
!
!
!
banner motd ^C
*****
* ! Solo personal autorizado, por favor digitar su clave ! *
*****^C
!
!
line con 0
```

```
password CISCO
```

```
login
```

```
line vty 0 4
```

```
password CISCO
```

```
login
```

```
!
```

```
!
```

```
!
```

```
End
```

CONFIGURACIÓN ROUTER BOGOTA

```
Bogota#show running-config
```

```
Building configuration...
```

```
Current configuration : 975 bytes
```

```
version 12.4
```

```
no service timestamps log datetime msec
```

```
no service timestamps debug datetime msec
```

```
no service password-encryption
```

```
!
```

```
hostname Bogota
```

```
enable secret 5 $1$mERr$NJdjwh5wX8la/X8aC4RIu.
```

```
!
```

```
!
```

```
!
```

```
spanning-tree mode pvst
```

```
interface FastEthernet0/0
description Interface de conexion con la LAN CONTABILIDAD de BOGOTA
ip address 192.168.8.1 255.255.255.224
duplex auto
speed auto
!
interface FastEthernet0/1
no ip address
duplex auto
speed auto
shutdown
!
interface Serial0/1/0
description Interface de conexion con la WAN BARRANQUILLA
ip address 172.17.2.1 255.255.255.252
clock rate 56000
!
interface Serial0/1/1
description interfaz de conexion con la red WAN BUCARAMANGA
ip address 172.17.1.2 255.255.255.252
!
interface Vlan1
no ip address
```

```
shutdown
!
router rip
version 2
passive-interface FastEthernet0/0
network 172.17.0.0
network 192.168.8.0
!
ip classless
!
!
!
banner motd ^C
*****
* ! Solo personal autorizado, por favor digitar su clave ! *
*****^C
!
!
line con 0
password CISCO
login
line vty 0 4
password CISCO
```

login

!

End

CONFIGURACIÓN ROUTER BARRANQUILLA

Barranquilla#show running-config

Building configuration...

Current configuration : 973 bytes

!

version 12.4

no service timestamps log datetime msec

no service timestamps debug datetime msec

no service password-encryption

!

hostname Barranquilla

!

!

!

enable secret 5 \$1\$mERr\$NJdjwh5wX8la/X8aC4Rlu.

!

spanning-tree mode pvst

!

!

```
interface FastEthernet0/0
description Interfaz de conexion con la Red LAN VENTAS SUCURSAL 1
ip address 192.168.6.1 255.255.255.192
duplex auto
speed auto
```

!

```
interface FastEthernet0/1
no ip address
duplex auto
speed auto
shutdown
```

!

```
interface Serial0/1/0
description Interfaz de conexion con la Red WAN MEDELLIN
ip address 172.17.3.1 255.255.255.252
clock rate 56000
```

!

```
interface Serial0/1/1
description Interfaz de conexion con la Red WAN BOGOTA
ip address 172.17.2.2 255.255.255.252
interface Vlan1
no ip address
shutdown
```

```
router rip
version 2
passive-interface FastEthernet0/0
network 172.17.0.0
network 192.168.6.0
!
ip classless
!
!
!
banner motd ^C
*****
* ! Solo personal autorizado, por favor digitar su clave ! *
*****^C
!
!
!
!
line con 0
password CISCO
login
line vty 0 4
password CISCO
```

login

!

End

CONFIGURACIÓN ROUTER MEDELLÍN

Medellin#show running-config

Building configuration...

Current configuration : 1001 bytes

!

version 12.4

no service timestamps log datetime msec

no service timestamps debug datetime msec

no service password-encryption

!

hostname Medellin

!

!

!

enable secret 5 \$1\$mERr\$NJdjwh5wX8la/X8aC4Rlu.

!

!

!

spanning-tree mode pvst

```
interface FastEthernet0/0
description Interfaz de conexion de la red LAN ADMINISTRATIVOS
ip address 192.168.7.1 255.255.255.224
duplex auto
speed auto
```

!

```
interface FastEthernet0/1
no ip address
duplex auto
speed auto
shutdown
```

!

```
interface Serial0/1/0
description Interfaz de conexion de la red WAN CALI
ip address 172.17.4.1 255.255.255.252
clock rate 56000
```

!

```
interface Serial0/1/1
description Interfaz de conexion de la red WAN BARRANQUILLA
ip address 172.17.3.2 255.255.255.252
interface Vlan1
no ip address
shutdown
```

```
router rip
version 2
passive-interface FastEthernet0/0
network 172.17.0.0
network 192.168.7.0
!
ip classless
!
!
!
banner motd ^C
*****
* ! Solo personal autorizado, por favor digitar su clave ! *
*****^C
!
!
!
!
line con 0
password CISCO
login
line vty 0 4
password CISCO
```

login

!

End

CONFIGURACIÓN ROUTER CALI

Cali#show running-config

Building configuration...

Current configuration : 910 bytes

!

version 12.4

no service timestamps log datetime msec

no service timestamps debug datetime msec

no service password-encryption

!

hostname Cali

!

!

!

enable secret 5 \$1\$mERr\$NJdjwh5wX8la/X8aC4Rlu.

!

!

!

spanning-tree mode pvst

```
interface FastEthernet0/0
description Interfaz de conexion de la red LAN VENTAS SUCURSAL 2
ip address 192.168.5.1 255.255.255.192
duplex auto
speed auto
!
interface FastEthernet0/1
no ip address
duplex auto
speed auto
shutdown
!
interface Serial0/1/0
no ip address
shutdown
!
interface Serial0/1/1
description Interfaz de conexion de la red WAN MEDELLIN
ip address 172.17.4.2 255.255.255.252
!
interface Vlan1
no ip address
shutdown
```

```
router rip
version 2
passive-interface FastEthernet0/0
network 172.17.0.0
network 192.168.5.0
!
ip classless
!
!
!
banner motd ^C
*****
* ! Solo personal autorizado, por favor digitar su clave ! *
*****^C
!
!
!
!
line con 0
password CISCO
login
line vty 0 4
password CISCO
```

login

!

!

end

PRUEBAS DE CONEXIÓN



Ilustración 2. Diagrama de topología con Enrutamiento y Direcccionamiento



Ilustración 3. Prueba de Ping Router Bucaramanga exitosa

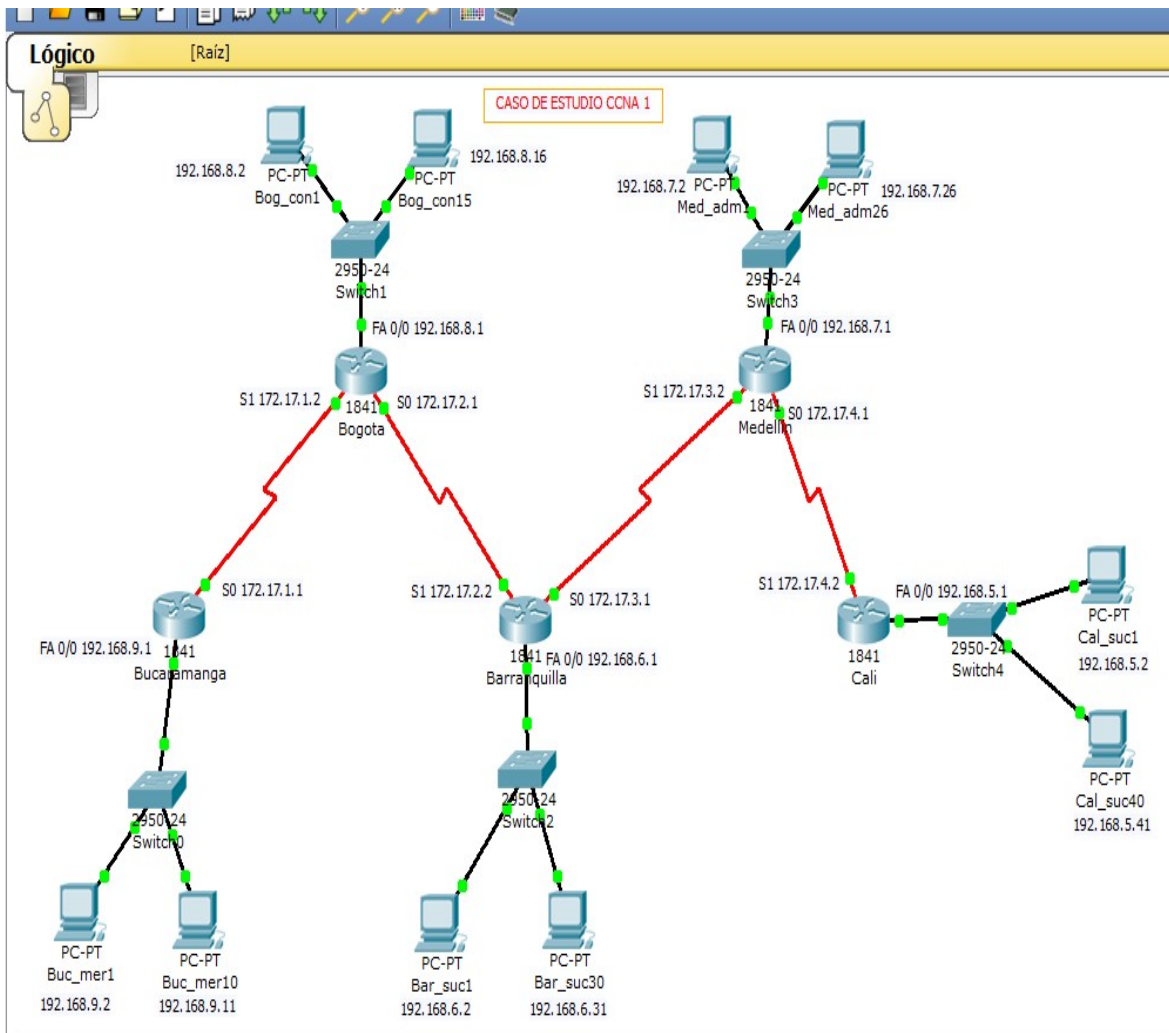

Ilustración 4. Prueba de Ping Router Bogotá exitosa

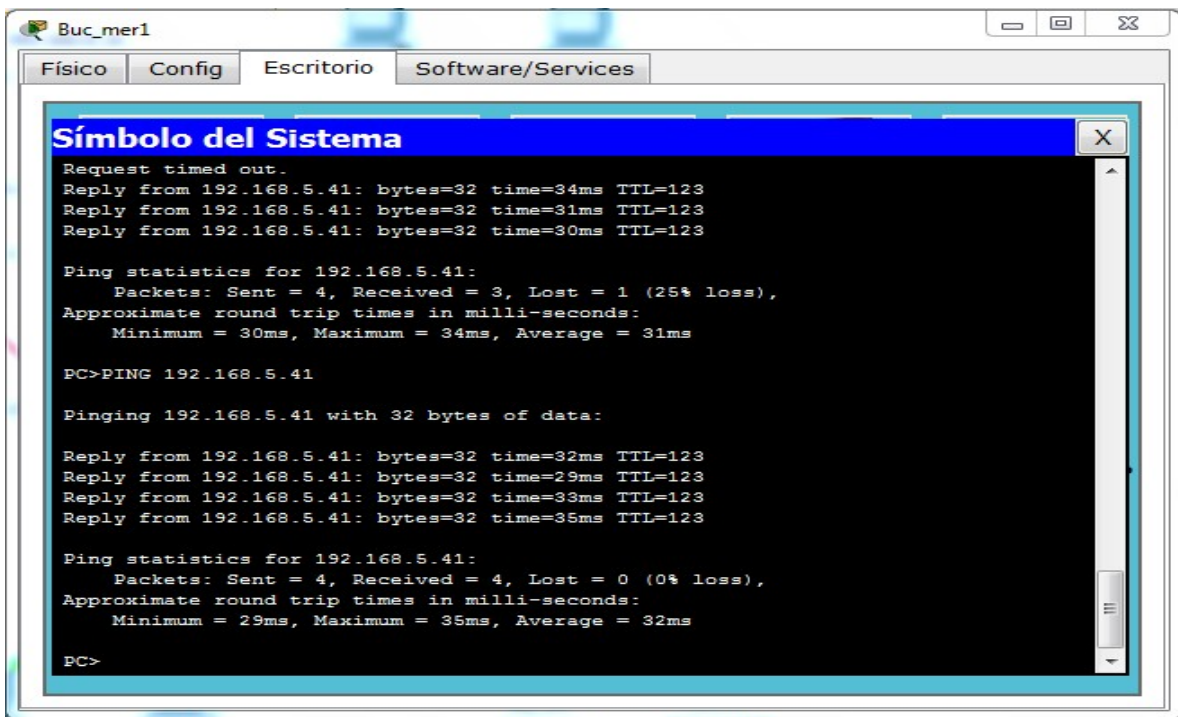

Ilustración 5. Prueba de Ping Router Barranquilla exitosa

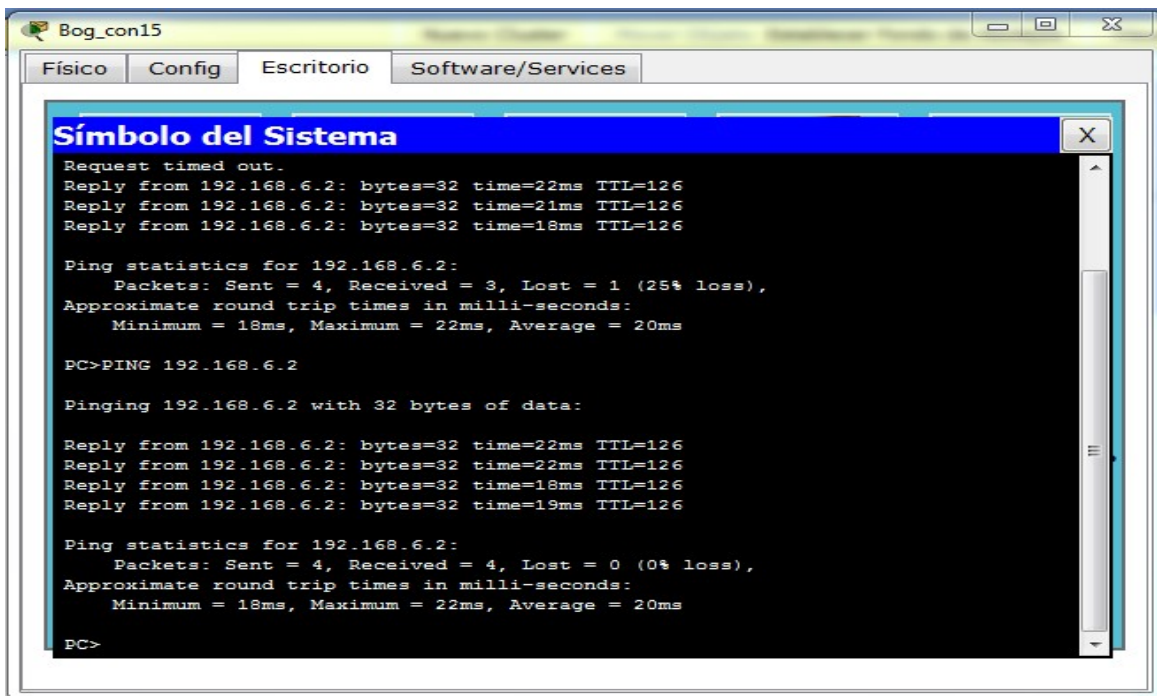

Ilustración 6. Prueba Tracer Route desde router Bucaramanga

SOLUCIÓN CASO DE ESTUDIO CCNA 2 EXPLORATION

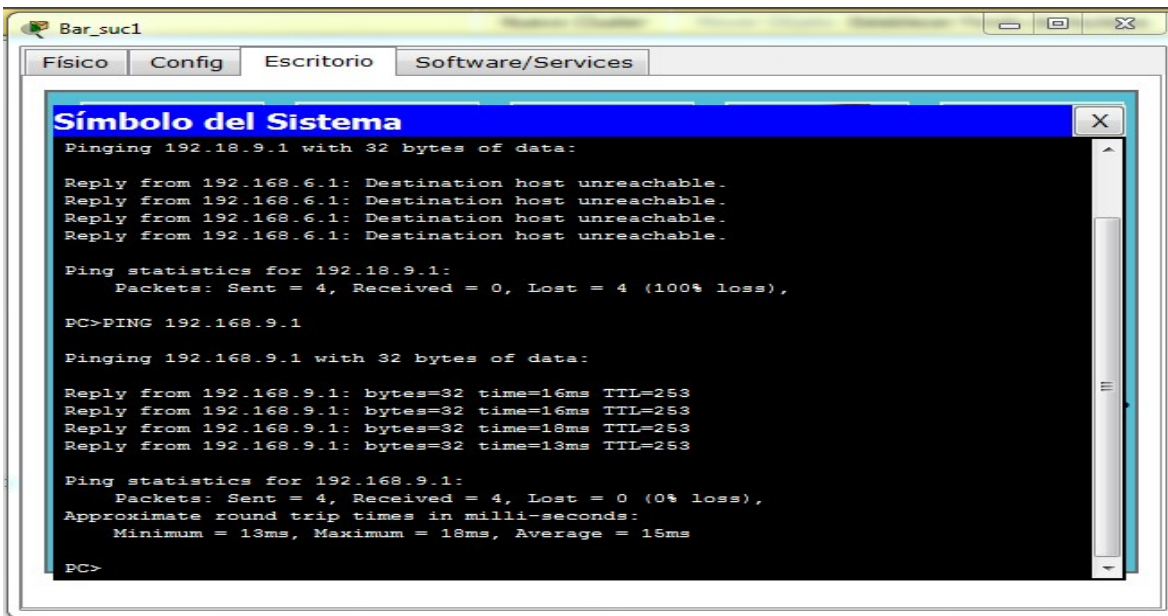
Enunciado Principal del caso de estudio

Se desea diseñar todo el esquema de enrutamiento para la topología que se ilustra en la siguiente figura, acorde con las pautas establecidas en cada una de las tareas que se definen a continuación. El estudiante deberá realizar el diseño completo y documentarlo indicando paso a paso la solución del mismo y las estrategias que utilizó para alcanzar el objetivo.

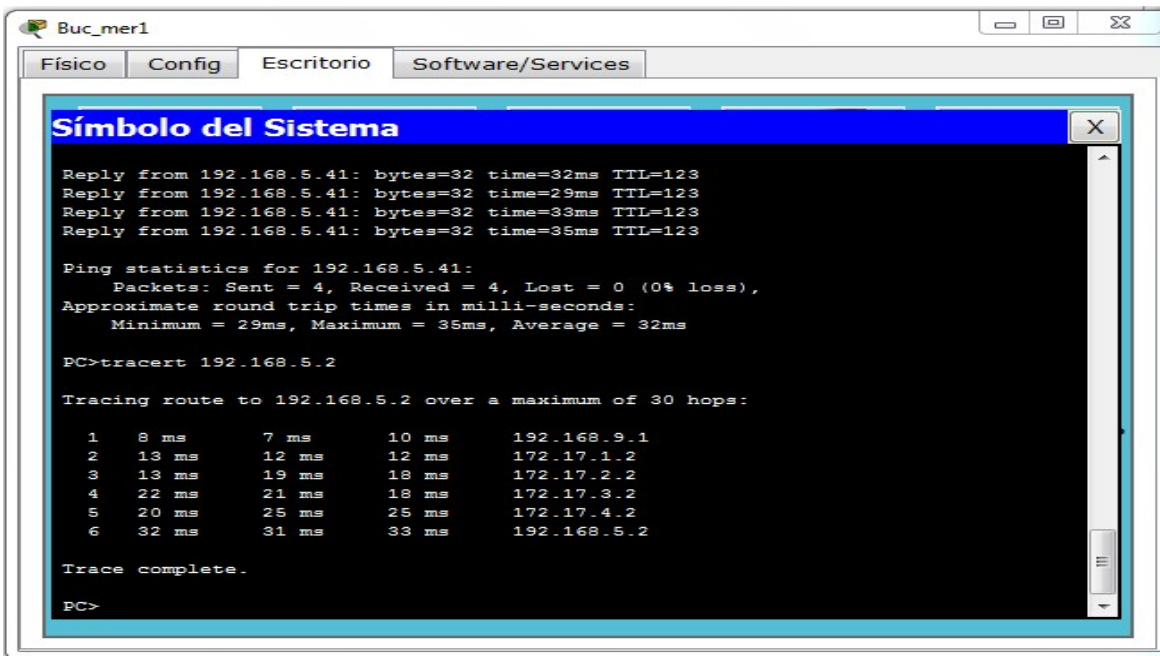
Diagrama de topología



Ilustración 7. Diagrama de topología Caso de estudio 2

Tarea 1:

Diseño y documentación de un esquema de direccionamiento

Utilice la 172.16.0.0/16 para crear un esquema de direccionamiento eficiente que cumpla los siguientes requisitos:

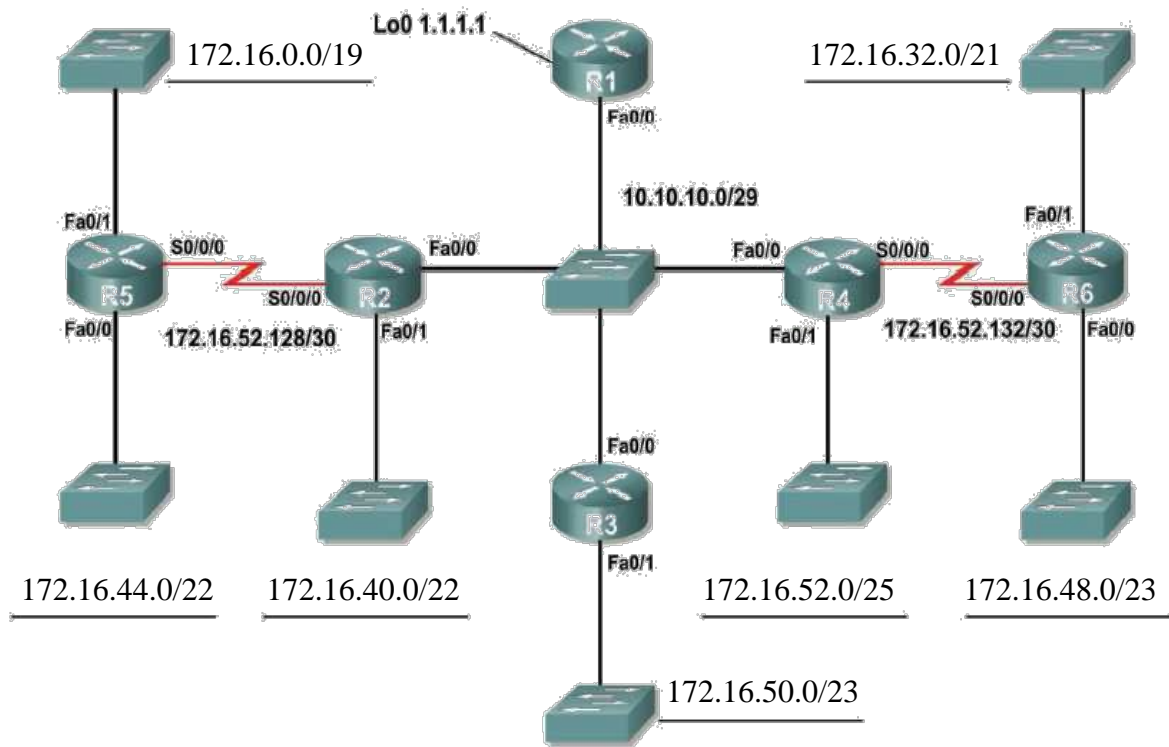
Nombre de host	Interfaz	Cantidad de hosts
R2	Fa0/1	1000
R3	Fa0/1	400
R4	Fa0/1	120
R5	Fa0/1	6000
R5	Fa0/0	800
R6	Fa0/1	2000
R6	Fa0/0	500

Tabla 9. Requisitos de direccionamiento

NOTA: observe que se han establecido las direcciones IP correspondientes a la interfaz Fa0/0 en los routers R1, R2, R3 y R4 tal como se ilustra en la siguiente tabla.

Dispositivo	Interfaz	Dirección IP	Máscara de subred
R1	Fa0/0	10.10.10.1	255.255.255.248
	Loopback0	1.1.1.1	255.255.255.255
R2	Fa0/0	10.10.10.2	255.255.255.248
	Fa0/1	172.16.40.1	255.255.252.0
	S0/0/0	172.16.52.130	255.255.255.252
R3	Fa0/0	10.10.10.3	255.255.255.248
	Fa0/1	172.16.50.1	255.255.254.0
R4	Fa0/0	10.10.10.4	255.255.255.248
	Fa0/1	172.16.52.1	255.255.255.128
	S0/0/0	172.16.52.133	255.255.255.252
R5	Fa0/0	172.16.44.1	255.255.252.0
	Fa0/1	172.16.0.1	255.255.224.0
	S0/0/0	172.16.52.129	255.255.255.252
R6	Fa0/0	172.16.48.1	255.255.254.0
	Fa0/1	172.16.32.1	255.255.248.0
	S0/0/0	172.16.52.134	255.255.255.252

Tabla 10. Esquema de direccionamiento

Se debe tener en cuenta que para establecer las direcciones IP para cada subred debe hacer uso de VLSM e identificar para cada una de ellas las siguientes direcciones IP:

1. **Dirección de Subred**
 2. **Dirección de Gateway**
 3. **Dirección IP del primer PC de la subred**
 4. **Dirección IP de último PC requerido en la subred. (Por ejemplo: Si la subred posee 800 host, cuál será la dirección IP del Host 800)**
 5. **Dirección de Broadcast**
1. **Máscara de Subred**

SUBRED	No HOST	N	OCTETO 3								OCTETO 4								DESCRIPCION	DIRECCION IP	MASCARA
			7	6	5	4	3	2	1	0	7	6	5	4	3	2	1	0			
R5-Fa0/1	6000	13	0	0	0	0	0	0	0	0	0	0	0	0	0	0	0	0	DIR. SUBRED	172.16.0.0	255.255.224.0
			0	0	0	0	0	0	0	0	0	0	0	0	0	0	0	1	GATEWAY	172.16.0.1	
			0	0	0	0	0	0	0	0	0	0	0	0	0	0	0	1	PC1	172.16.0.2	
			0	0	0	1	0	1	1	1	0	1	1	1	0	0	0	1	PC 6000	172.16.23.113	
			0	0	0	1	1	1	1	1	1	1	1	1	1	1	1	1	BROADCAST	172.16.31.255	
R6-Fa0/1	2000	11	0	0	1	0	0	0	0	0	0	0	0	0	0	0	0	0	DIR. SUBRED	172.16.32.0	255.255.248.0
			0	0	1	0	0	0	0	0	0	0	0	0	0	0	0	1	GATEWAY	172.16.32.1	
			0	0	1	0	0	0	0	0	0	0	0	0	0	0	0	1	PC1	172.16.32.2	
			0	0	1	0	0	1	1	1	1	1	0	1	0	0	0	1	PC 2000	172.16.39.209	
			0	0	1	0	0	1	1	1	1	1	1	1	1	1	1	1	BROADCAST	172.16.39.255	
R2-Fa0/1	1000	10	0	0	1	0	1	0	0	0	0	0	0	0	0	0	0	0	DIR. SUBRED	172.16.40.0	255.255.252.0
			0	0	1	0	1	0	0	0	0	0	0	0	0	0	0	1	GATEWAY	172.16.40.1	
			0	0	1	0	1	0	0	0	0	0	0	0	0	0	0	1	PC1	172.16.40.2	
			0	0	1	0	1	0	1	1	1	1	1	0	1	0	0	1	PC 1000	172.16.43.233	
			0	0	1	0	1	0	1	1	1	1	1	1	1	1	1	1	BROADCAST	172.16.43.255	
R5-Fa0/0	800	10	0	0	1	0	1	1	0	0	0	0	0	0	0	0	0	0	DIR. SUBRED	172.16.44.0	255.255.252.0
			0	0	1	0	1	1	0	0	0	0	0	0	0	0	0	1	GATEWAY	172.16.44.1	
			0	0	1	0	1	1	0	0	0	0	0	0	0	0	0	1	PC1	172.16.44.2	
			0	0	1	0	1	1	1	1	0	0	1	0	0	0	0	1	PC 800	172.16.47.33	
			0	0	1	0	1	1	1	1	1	1	1	1	1	1	1	1	BROADCAST	172.16.47.255	
R6-Fa0/0	500	9	0	0	1	1	0	0	0	0	0	0	0	0	0	0	0	0	DIR. SUBRED	172.16.48.0	255.255.254.0
			0	0	1	1	0	0	0	0	0	0	0	0	0	0	0	1	GATEWAY	172.16.48.1	
			0	0	1	1	0	0	0	0	0	0	0	0	0	0	0	1	PC1	172.16.48.2	
			0	0	1	1	0	0	0	1	1	1	1	0	1	0	1	0	PC 500	172.16.49.245	
			0	0	1	1	0	0	0	1	1	1	1	1	1	1	1	1	BROADCAST	172.16.49.255	
R3-Fa0/1	400	9	0	0	1	1	0	0	1	0	0	0	0	0	0	0	0	0	DIR. SUBRED	172.16.50.0	255.255.254.0
			0	0	1	1	0	0	1	0	0	0	0	0	0	0	0	1	GATEWAY	172.16.50.1	
			0	0	1	1	0	0	1	0	0	0	0	0	0	0	0	1	PC1	172.16.50.2	
			0	0	1	1	0	0	1	1	1	0	0	1	0	0	0	1	PC 400	172.16.51.145	
			0	0	1	1	0	0	1	1	1	1	1	1	1	1	1	1	BROADCAST	172.16.51.255	
R4-Fa0/1	120	7	0	0	1	1	0	1	0	0	0	0	0	0	0	0	0	0	DIR. SUBRED	172.16.52.0	255.255.255.128
			0	0	1	1	0	1	0	0	0	0	0	0	0	0	0	1	GATEWAY	172.16.52.1	
			0	0	1	1	0	1	0	0	0	0	0	0	0	0	1	2	PC1	172.16.52.2	
			0	0	1	1	0	1	0	0	0	1	1	1	0	0	1	0	PC 120	172.16.52.121	
			0	0	1	1	0	1	0	0	0	1	1	1	1	1	1	1	BROADCAST	172.16.52.127	
WAN1	2	2	0	0	1	1	0	1	0	0	1	0	0	0	0	0	0	0	DIR. SUBRED	172.16.52.128	255.255.255.252
			0	0	1	1	0	1	0	0	1	0	0	0	0	0	0	1	ROUTER5 SO	172.16.52.129	
			0	0	1	1	0	1	0	0	1	0	0	0	0	0	0	1	ROUTER2 SO	172.16.52.130	
			0	0	1	1	0	1	0	0	1	0	0	0	0	0	0	1	BROADCAST	172.16.52.131	

Tabla 11. VLSM para esquema de direccionamiento

SUBRED	No HOST	N	OCTETO 3								OCTETO 4								DESCRIPCION	DIRECCION IP	MASCARA
			7	6	5	4	3	2	1	0	7	6	5	4	3	2	1	0			
WAN2	2	2	0	0	1	1	0	1	0	0	1	0	0	0	0	1	0	0	DIR. SUBRED	172.16.52.132	255.255.255.252
			0	0	1	1	0	1	0	0	1	0	0	0	0	1	0	1	ROUTER4 SO	172.16.52.133	
			0	0	1	1	0	1	0	0	1	0	0	0	0	1	1	0	ROUTER6 SO	172.16.52.134	
			0	0	1	1	0	1	0	0	1	0	0	0	0	1	1	1	BROADCAST	172.16.52.135	

Tarea 2:

Aplicación de una configuración básica.

Paso 1: En cada router, utilice el siguiente cuadro para completar las configuraciones básicas de contraseñas del router.

Contraseña de consola	Contraseña de VTY	Contraseña secreta de enable	Frecuencia de reloj (si corresponde)
cisco	cisco	cisco	56000

Tabla 12. Configuraciones Básicas a los routers

La siguiente figura muestra las configuraciones básicas que se deben realizar a cada uno de los routers, con sus respectivas órdenes:



Ilustración 8. Ejemplo de configuración básica

Tarea 3:

Configurar el enrutamiento OSPF

Paso 1: Configurar el enrutamiento OSPF en cada router.

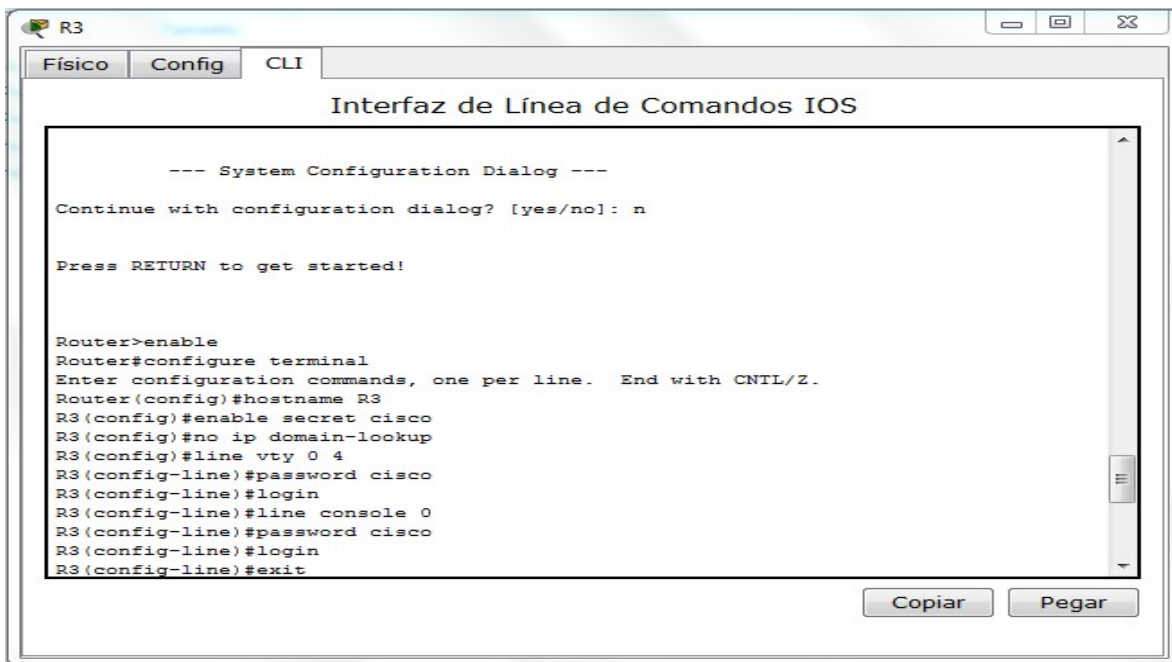
Paso 2: Verifique que se hayan aprendido todas las rutas.

```
R3(config)#
R3(config)#
R3(config)#
R3(config)#
R3(config)#router ospf 1
R3(config-router)#network 10.10.10.0 0.0.0.7 area 0
R3(config-router)#
00:15:47: %OSPF-5-ADJCHG: Process 1, Nbr 172.16.52.133 on FastEthernet0/0 from L
LOADING to FULL, Loading Done

00:15:47: %OSPF-5-ADJCHG: Process 1, Nbr 172.16.52.130 on FastEthernet0/0 from L
LOADING to FULL, Loading Done

R3(config-router)#network 172.16.50.0 0.0.1.255 area 0
R3(config-router)#
R3(config-router)#
```

Ilustración 9. Configuración de enrutamiento OSPF

Tarea 4:

Ajuste refinado de OSPF

Paso 1: Utilice las siguientes pautas para completar esta tarea:

6. R1 nunca participará en una elección DR/BDR.
7. R2 siempre será el DR
8. R3 y R4 tendrán la misma prioridad de 100.
9. R4 debe ser siempre el BDR

```
R2#show ip ospf interface
FastEthernet0/0 is up, line protocol is up
Internet address is 10.10.10.2/29, Area 0
Process ID 1, Router ID 172.16.52.130, Network Type BROADCAST, Cost: 1
Transmit Delay is 1 sec, State DR, Priority 255
Designated Router (ID) 172.16.52.130, Interface address 10.10.10.2
Backup Designated Router (ID) 172.16.52.133, Interface address 10.10.10.4
Timer intervals configured, Hello 10, Dead 40, Wait 40, Retransmit 5
Hello due in 00:00:09
Index 1/1, flood queue length 0
Next 0x0(0)/0x0(0)
Last flood scan length is 1, maximum is 1
Last flood scan time is 0 msec, maximum is 0 msec
Neighbor Count is 2, Adjacent neighbor count is 2
  Adjacent with neighbor 172.16.52.133 (Backup Designated Router)
  Adjacent with neighbor 172.16.50.1
Suppress hello for 0 neighbor(s)
FastEthernet0/1 is up, line protocol is up
Internet address is 172.16.40.1/22, Area 0
Process ID 1, Router ID 172.16.52.130, Network Type BROADCAST, Cost: 1
Transmit Delay is 1 sec, State DR, Priority 1
Designated Router (ID) 172.16.52.130, Interface address 172.16.40.1
No backup designated router on this network
Timer intervals configured, Hello 10, Dead 40, Wait 40, Retransmit 5
Hello due in 00:00:03
Index 2/2, flood queue length 0
Next 0x0(0)/0x0(0)
Last flood scan length is 1, maximum is 1
Last flood scan time is 0 msec, maximum is 0 msec
```

Ilustración 10. R2 será el DR

```
R4#show ip ospf interface
Password:
FastEthernet0/0 is up, line protocol is up
Internet address is 10.10.10.4/29, Area 0
Process ID 1, Router ID 172.16.52.133, Network Type BROADCAST, Cost: 1
Transmit Delay is 1 sec, State BDR, Priority 100
Designated Router (ID) 172.16.52.130, Interface address 10.10.10.2
Backup Designated Router (ID) 172.16.52.133, Interface address 10.10.10.4
Timer intervals configured, Hello 10, Dead 40, Wait 40, Retransmit 5
Hello due in 00:00:04
Index 1/1, flood queue length 0
Next 0x0(0)/0x0(0)
Last flood scan length is 1, maximum is 1
Last flood scan time is 0 msec, maximum is 0 msec
Neighbor Count is 2, Adjacent neighbor count is 2
  Adjacent with neighbor 172.16.52.130 (Designated Router)
  Adjacent with neighbor 172.16.50.1
Suppress hello for 0 neighbor(s)
FastEthernet0/1 is up, line protocol is up
Internet address is 172.16.52.1/25, Area 0
Process ID 1, Router ID 172.16.52.133, Network Type BROADCAST, Cost: 1
Transmit Delay is 1 sec, State DR, Priority 1
Designated Router (ID) 172.16.52.133, Interface address 172.16.52.1
No backup designated router on this network
Timer intervals configured, Hello 10, Dead 40, Wait 40, Retransmit 5
```

Ilustración 11. R4 será el BDR



Ilustración 12. R3 reconoce sus vecinos DR y BDR

NOTA: SE DEBEN ESTABLECER TODAS LAS PRIORIDADES EN FA0/0

Paso 2: Fuerce una elección DR/DBR.

Tarea 5:

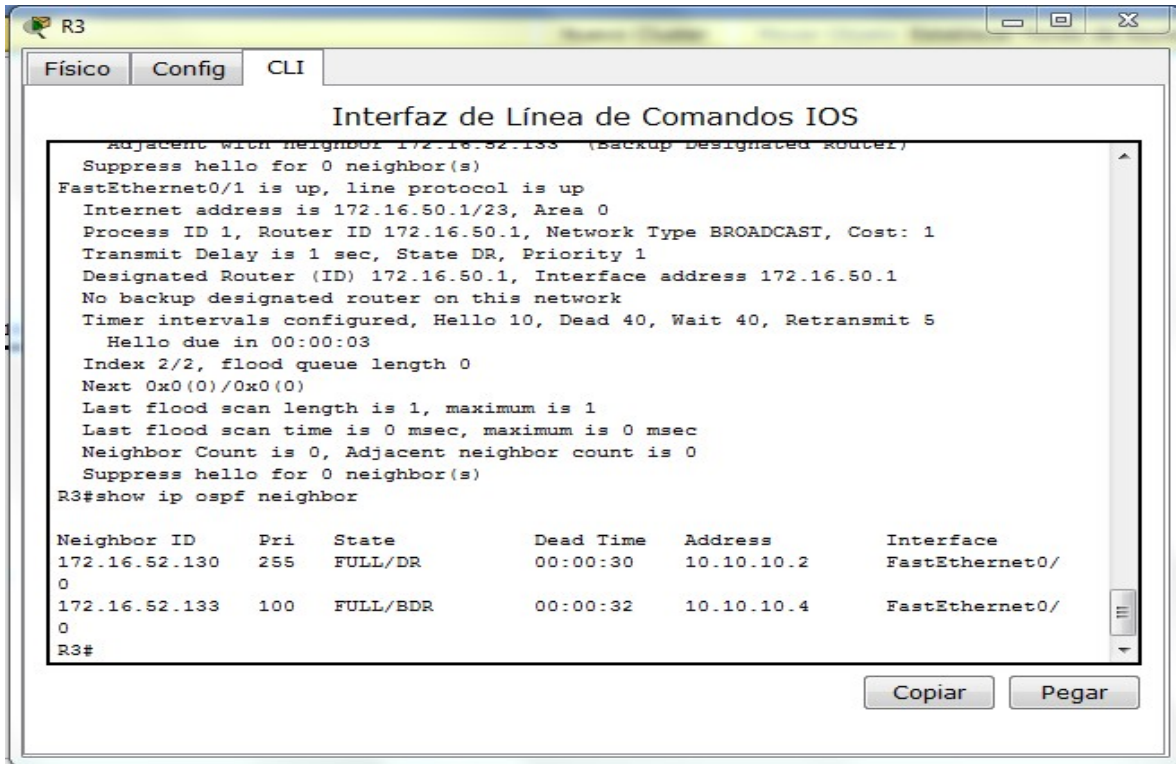
Configuración de un loopback

Paso 1: En R1 configure un loopback con una dirección 1.1.1.1/32.

Paso 2: Cree una ruta por defecto al loopback

Paso 3: Propague la ruta con actualizaciones OSPF.

```
R1(config-if)#interface loopback0
%LINK-5-CHANGED: Interface Loopback0, changed state to up
%LINEPROTO-5-UPDOWN: Line protocol on Interface Loopback0, changed state to up
R1(config-if)#ip address 10.10.10.1 255.255.255.255
% 10.10.10.1 overlaps with FastEthernet0/0
R1(config-if)#ip address 1.1.1.1 255.255.255.255
R1(config-if)#description Interfaz de conexion de la red loopback0 R1
R1(config-if)#interface fastethernet 0/0
R1(config-if)#description Interfaz de conexion de la red LAN R1
R1(config-if)#END
R1#
%SYS-5-CONFIG_I: Configured from console by console

R1#WR
Building configuration...
[OK]
R1#configure terminal
Enter configuration commands, one per line. End with CNTL/Z.
R1(config)#ip route 0.0.0.0 0.0.0.0 loopback0
R1(config)#router ospf 1
R1(config-router)#default-information originate
R1(config-router)#
```

Copiar Pegar

Ilustración 13. Configuración Loopback, ruta por defecto y actualización OSPF

Tarea 6:

Visualización de las actualizaciones OSPF.

Paso 1: Ingrese al modo Simulación

Paso 2: Seleccione solamente OSPF en el filtro.

Paso 3: Visualice las actualizaciones.



Ilustración 14: Topología caso de estudio 2



Ilustración 15. Actualizaciones OSPF

CONFIGURACION FINAL R1

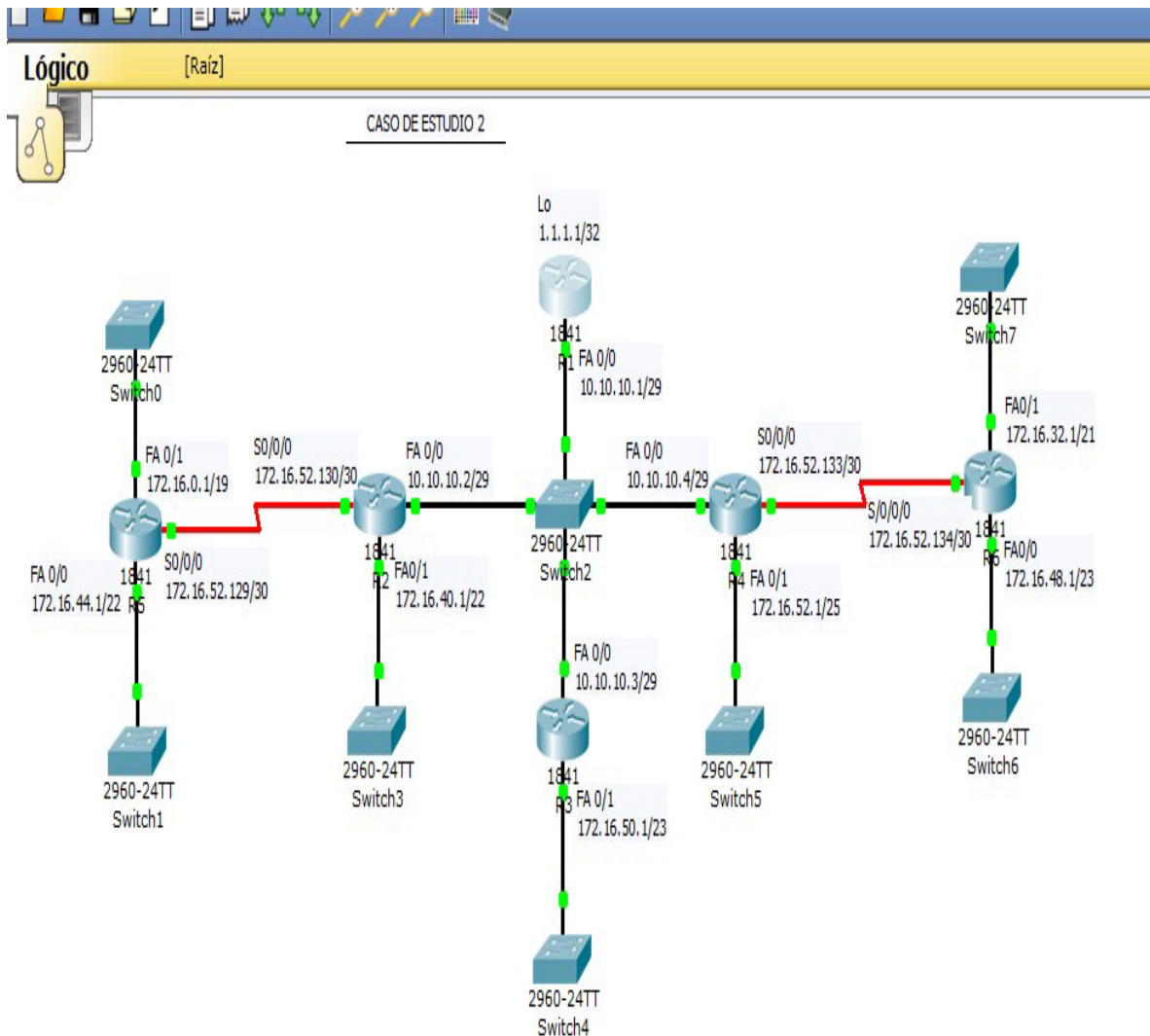
R1#show running-config

Building configuration...

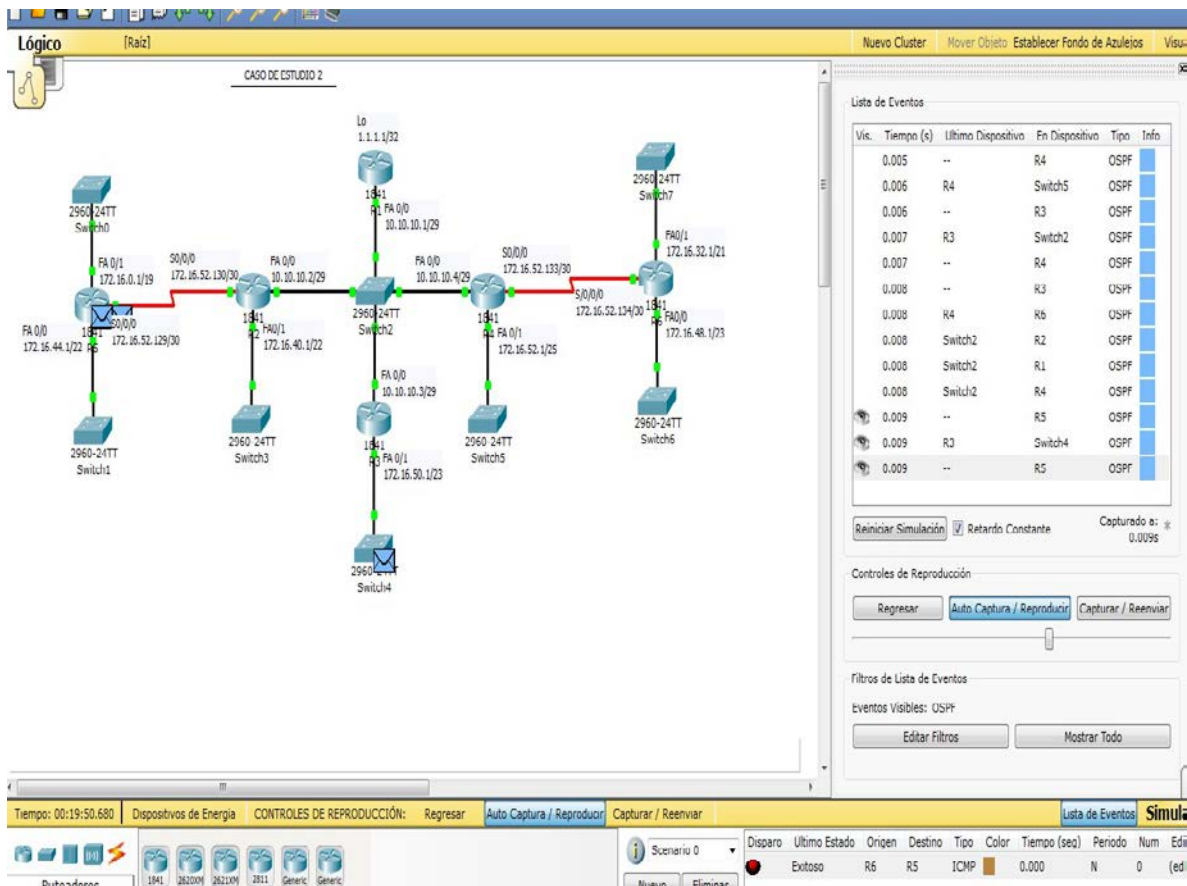
Current configuration : 1251 bytes

!

version 12.4

no service timestamps log datetime msec

no service timestamps debug datetime msec

no service password-encryption

```
hostname R1

!

!

enable secret 5 $1$mERr$hx5rVt7rPNoS4wqbXKX7m0

!

!

!

!

no ip domain-lookup

!

!

spanning-tree mode pvst

!

interface Loopback0

  description Interfaz de conexion de la red loopback0 R1

  ip address 1.1.1.1 255.255.255.255

!

interface FastEthernet0/0

  description Interfaz de conexion de la red LAN R1

  ip address 10.10.10.1 255.255.255.248

  ip ospf priority 0

  duplex auto
```

speed auto

!

interface FastEthernet0/1

no ip address

duplex auto

speed auto

shutdown

!

interface Serial0/0/0

no ip address

clock rate 2000000

shutdown

!

interface Serial0/0/1

no ip address

clock rate 2000000

shutdown

!

interface Vlan1

no ip address

shutdown

!

```
router ospf 1

log-adjacency-changes

network 10.10.10.0 0.0.0.7 area 0

default-information originate

!

ip classless

ip route 0.0.0.0 0.0.0.0 Loopback0

!

!

banner motd ^C

*****

* ! Solo Personal Autorizado, por favor digite su clave ! *

*****

^C

!

!

!

!

line con 0

password cisco

login

line vty 0 4
```

password cisco

login

!

!

!

end

R1#show ip ospf interface

FastEthernet0/0 is up, line protocol is up

Internet address is 10.10.10.1/29, Area 0

Process ID 1, Router ID 1.1.1.1, Network Type BROADCAST, Cost: 1

Transmit Delay is 1 sec, State DROTHER, Priority 0

Designated Router (ID) 172.16.52.130, Interface address 10.10.10.2

Backup Designated Router (ID) 172.16.52.133, Interface address 10.10.10.4

Timer intervals configured, Hello 10, Dead 40, Wait 40, Retransmit 5

Hello due in 00:00:04

Index 1/1, flood queue length 0

Next 0x0(0)/0x0(0)

Last flood scan length is 1, maximum is 1

Last flood scan time is 0 msec, maximum is 0 msec

Neighbor Count is 3, Adjacent neighbor count is 2

Adjacent with neighbor 172.16.52.130 (Designated Router)

Adjacent with neighbor 172.16.52.133 (Backup Designated Router)

Suppress hello for 0 neighbor(s)

R1#show ip ospf neighbor

Neighbor ID	Pri	State	Dead Time	Address	Interface
172.16.52.133	100	FULL/BDR	00:00:32	10.10.10.4	FastEthernet0/0
172.16.50.1	100	2WAY/DROTHER	00:00:32	10.10.10.3	FastEthernet0/0
172.16.52.130	255	FULL/DR	00:00:32	10.10.10.2	FastEthernet0/0

R1#show ip route

Codes: C - connected, S - static, I - IGRP, R - RIP, M - mobile, B - BGP

D - EIGRP, EX - EIGRP external, O - OSPF, IA - OSPF inter area

N1 - OSPF NSSA external type 1, N2 - OSPF NSSA external type 2

E1 - OSPF external type 1, E2 - OSPF external type 2, E - EGP

i - IS-IS, L1 - IS-IS level-1, L2 - IS-IS level-2, ia - IS-IS inter area

* - candidate default, U - per-user static route, o - ODR

P - periodic downloaded static route

Gateway of last resort is 0.0.0.0 to network 0.0.0.0

1.0.0.0/32 is subnetted, 1 subnets

C 1.1.1.1 is directly connected, Loopback0

10.0.0.0/29 is subnetted, 1 subnets

C 10.10.10.0 is directly connected, FastEthernet0/0

172.16.0.0/16 is variably subnetted, 9 subnets, 6 masks

O 172.16.0.0/19 [110/66] via 10.10.10.2, 00:01:16, FastEthernet0/0

O 172.16.32.0/21 [110/66] via 10.10.10.4, 00:01:16, FastEthernet0/0

O 172.16.40.0/22 [110/2] via 10.10.10.2, 00:01:16, FastEthernet0/0

O 172.16.44.0/22 [110/66] via 10.10.10.2, 00:01:16, FastEthernet0/0

O 172.16.48.0/23 [110/66] via 10.10.10.4, 00:01:16, FastEthernet0/0

O 172.16.50.0/23 [110/2] via 10.10.10.3, 00:01:16, FastEthernet0/0

O 172.16.52.0/25 [110/2] via 10.10.10.4, 00:01:16, FastEthernet0/0

O 172.16.52.128/30 [110/65] via 10.10.10.2, 00:01:16, FastEthernet0/0

O 172.16.52.132/30 [110/65] via 10.10.10.4, 00:01:16, FastEthernet0/0

S* 0.0.0.0/0 is directly connected, Loopback0

R1#show ip protocols

Routing Protocol is "ospf 1"

Outgoing update filter list for all interfaces is not set

Incoming update filter list for all interfaces is not set

Router ID 1.1.1.1

It is an autonomous system boundary router

Redistributing External Routes from,

Number of areas in this router is 1. 1 normal 0 stub 0 nssa

Maximum path: 4

Routing for Networks:

10.10.10.0 0.0.0.7 area 0

Routing Information Sources:

Gateway	Distance	Last Update
1.1.1.1	110	00:14:13
172.16.50.1	110	00:14:23
172.16.52.129	110	00:14:57
172.16.52.130	110	00:14:23
172.16.52.133	110	00:14:18
172.16.52.134	110	00:14:57

Distance: (default is 110)

CONFIGURACION FINAL R2

R2#show running-config

Building configuration...

Current configuration : 1284 bytes

!

version 12.4

no service timestamps log datetime msec

no service timestamps debug datetime msec

no service password-encryption

hostname R2

```
enable secret 5 $1$mERr$hx5rVt7rPNoS4wqbXKX7m0
```

```
!
```

```
!
```

```
!
```

```
!
```

```
no ip domain-lookup
```

```
!
```

```
!
```

```
spanning-tree mode pvst
```

```
!
```

```
!
```

```
!
```

```
!
```

```
interface FastEthernet0/0
```

```
description Interfaz de conexion con las redes LAN R1, R3 y R4
```

```
ip address 10.10.10.2 255.255.255.248
```

```
ip ospf priority 255
```

```
duplex auto
```

```
speed auto
```

```
!
```

```
interface FastEthernet0/1
```

```
description Interfaz de conexion con la red LAN R2
```

```
ip address 172.16.40.1 255.255.252.0
```

```
duplex auto
```

```
speed auto
```

```
!
```

```
interface Serial0/0/0
```

```
description Interfaz de conexion con la red WAN R5
```

```
ip address 172.16.52.130 255.255.255.252
```

```
clock rate 56000
```

```
!
```

```
interface Serial0/0/1
```

```
no ip address
```

```
clock rate 2000000
```

```
shutdown
```

```
!
```

```
interface Vlan1
```

```
no ip address
```

```
shutdown
```

```
!
```

```
router ospf 1
```

```
log-adjacency-changes
```

```
network 10.10.10.0 0.0.0.7 area 0
```

```
network 172.16.40.0 0.0.3.255 area 0
```

```
network 172.16.52.128 0.0.0.3 area 0
```

```
!
```

```
ip classless
```

```
!
```

```
!
```

```
!
```

```
banner motd ^C
```

```
*****
```

```
* ! Solo Personal Autorizado, por favor digite su clave ! *
```

```
*****
```

```
^C
```

```
!
```

```
!
```

```
!
```

```
!
```

```
line con 0
```

```
password cisco
```

```
login
```

```
line vty 0 4
```

```
password cisco
```

```
login
```

```
!
```

end

R2#show ip route

Codes: C - connected, S - static, I - IGRP, R - RIP, M - mobile, B - BGP

D - EIGRP, EX - EIGRP external, O - OSPF, IA - OSPF inter area

N1 - OSPF NSSA external type 1, N2 - OSPF NSSA external type 2

E1 - OSPF external type 1, E2 - OSPF external type 2, E - EGP

i - IS-IS, L1 - IS-IS level-1, L2 - IS-IS level-2, ia - IS-IS inter area

* - candidate default, U - per-user static route, o - ODR

P - periodic downloaded static route

Gateway of last resort is 10.10.10.1 to network 0.0.0.0

10.0.0.0/29 is subnetted, 1 subnets

C 10.10.10.0 is directly connected, FastEthernet0/0

172.16.0.0/16 is variably subnetted, 9 subnets, 6 masks

O 172.16.0.0/19 [110/65] via 172.16.52.129, 00:40:54, Serial0/0/0

O 172.16.32.0/21 [110/66] via 10.10.10.4, 00:40:09, FastEthernet0/0

C 172.16.40.0/22 is directly connected, FastEthernet0/1

O 172.16.44.0/22 [110/65] via 172.16.52.129, 00:40:54, Serial0/0/0

O 172.16.48.0/23 [110/66] via 10.10.10.4, 00:40:09, FastEthernet0/0

O 172.16.50.0/23 [110/2] via 10.10.10.3, 00:40:19, FastEthernet0/0

O 172.16.52.0/25 [110/2] via 10.10.10.4, 00:40:09, FastEthernet0/0

```
C    172.16.52.128/30 is directly connected, Serial0/0/0
O    172.16.52.132/30 [110/65] via 10.10.10.4, 00:40:09, FastEthernet0/0
O*E2 0.0.0.0/0 [110/1] via 10.10.10.1, 00:40:09, FastEthernet0/0
```

R2#show ip ospf interface

```
FastEthernet0/1 is up, line protocol is up

Internet address is 172.16.40.1/22, Area 0

Process ID 1, Router ID 172.16.52.130, Network Type BROADCAST, Cost: 1

Transmit Delay is 1 sec, State DR, Priority 1

Designated Router (ID) 172.16.52.130, Interface address 172.16.40.1

No backup designated router on this network

Timer intervals configured, Hello 10, Dead 40, Wait 40, Retransmit 5

Hello due in 00:00:00

Index 1/1, flood queue length 0

Next 0x0(0)/0x0(0)

Last flood scan length is 1, maximum is 1

Last flood scan time is 0 msec, maximum is 0 msec

Neighbor Count is 0, Adjacent neighbor count is 0

Suppress hello for 0 neighbor(s)

FastEthernet0/0 is up, line protocol is up

Internet address is 10.10.10.2/29, Area 0

Process ID 1, Router ID 172.16.52.130, Network Type BROADCAST, Cost: 1
```

Transmit Delay is 1 sec, State DR, Priority 255

Designated Router (ID) 172.16.52.130, Interface address 10.10.10.2

Backup Designated Router (ID) 172.16.52.133, Interface address 10.10.10.4

Timer intervals configured, Hello 10, Dead 40, Wait 40, Retransmit 5

 Hello due in 00:00:00

Index 2/2, flood queue length 0

Next 0x0(0)/0x0(0)

Last flood scan length is 1, maximum is 1

Last flood scan time is 0 msec, maximum is 0 msec

Neighbor Count is 3, Adjacent neighbor count is 3

 Adjacent with neighbor 172.16.50.1

 Adjacent with neighbor 1.1.1.1

 Adjacent with neighbor 172.16.52.133 (Backup Designated Router)

Suppress hello for 0 neighbor(s)

Serial0/0/0 is up, line protocol is up

Internet address is 172.16.52.130/30, Area 0

Process ID 1, Router ID 172.16.52.130, Network Type POINT-TO-POINT, Cost: 64

Transmit Delay is 1 sec, State POINT-TO-POINT, Priority 0

No designated router on this network

No backup designated router on this network

Timer intervals configured, Hello 10, Dead 40, Wait 40, Retransmit 5

 Hello due in 00:00:00

Index 3/3, flood queue length 0

Next 0x0(0)/0x0(0)

Last flood scan length is 1, maximum is 1

Last flood scan time is 0 msec, maximum is 0 msec

Neighbor Count is 1 , Adjacent neighbor count is 1

Adjacent with neighbor 172.16.52.129

Suppress hello for 0 neighbor(s)

R2#show ip ospf neighbor

Neighbor ID	Pri	State	Dead Time	Address	Interface
172.16.50.1	100	FULL/DROTHER	00:00:32	10.10.10.3	FastEthernet0/0
1.1.1.1	0	FULL/DROTHER	00:00:32	10.10.10.1	FastEthernet0/0
172.16.52.133	100	FULL/BDR	00:00:32	10.10.10.4	FastEthernet0/0
172.16.52.129	0	FULL/ -	00:00:32	172.16.52.129	Serial0/0/0

R2#show ip protocols

Routing Protocol is "ospf 1"

Outgoing update filter list for all interfaces is not set

Incoming update filter list for all interfaces is not set

Router ID 172.16.52.130

Number of areas in this router is 1. 1 normal 0 stub 0 nssa

Maximum path: 4

Routing for Networks:

10.10.10.0 0.0.0.7 area 0

172.16.40.0 0.0.3.255 area 0

172.16.52.128 0.0.0.3 area 0

Routing Information Sources:

Gateway	Distance	Last Update
1.1.1.1	110	00:11:12
172.16.50.1	110	00:11:22
172.16.52.129	110	00:11:55
172.16.52.130	110	00:11:21
172.16.52.133	110	00:11:12
172.16.52.134	110	00:11:56

Distance: (default is 110)

CONFIGURACION FINAL R3

R3#show running-config

Building configuration...

Current configuration : 1173 bytes

!

version 12.4

no service timestamps log datetime msec

no service timestamps debug datetime msec

no service password-encryption

```
hostname R3

!

!

!

enable secret 5 $1$mERr$hx5rVt7rPNoS4wqbXKX7m0

!

!

!

!

no ip domain-lookup

spanning-tree mode pvst

interface FastEthernet0/0

description Interfaz de conexion de la red LAN R3

ip address 10.10.10.3 255.255.255.248

ip ospf priority 100

duplex auto

speed auto

!

interface FastEthernet0/1

description Interfaz de conexion de la red LAN R3

ip address 172.16.50.1 255.255.254.0

duplex auto
```

```
speed auto

!

interface Serial0/0/0

no ip address

clock rate 2000000

shutdown

!

interface Serial0/0/1

no ip address

clock rate 2000000

shutdown

!

interface Vlan1

no ip address

shutdown

!

router ospf 1

log-adjacency-changes

network 10.10.10.0 0.0.0.7 area 0

network 172.16.50.0 0.0.1.255 area 0

!

ip classless
```

```
banner motd ^C
```

```
*****
```

```
* ! Solo Personal Autorizado, por favor digite su clave ! *
```

```
*****
```

```
^C
```

```
!
```

```
!
```

```
line con 0
```

```
password cisco
```

```
login
```

```
line vty 0 4
```

```
password cisco
```

```
login
```

```
!
```

```
end
```

R3#show ip route

Codes: C - connected, S - static, I - IGRP, R - RIP, M - mobile, B - BGP

D - EIGRP, EX - EIGRP external, O - OSPF, IA - OSPF inter area

N1 - OSPF NSSA external type 1, N2 - OSPF NSSA external type 2

E1 - OSPF external type 1, E2 - OSPF external type 2, E - EGP

i - IS-IS, L1 - IS-IS level-1, L2 - IS-IS level-2, ia - IS-IS inter area

* - candidate default, U - per-user static route, o - ODR

P - periodic downloaded static route

Gateway of last resort is 10.10.10.1 to network 0.0.0.0

10.0.0.0/29 is subnetted, 1 subnets

C 10.10.10.0 is directly connected, FastEthernet0/0

172.16.0.0/16 is variably subnetted, 9 subnets, 6 masks

O 172.16.0.0/19 [110/66] via 10.10.10.2, 00:49:03, FastEthernet0/0

O 172.16.32.0/21 [110/66] via 10.10.10.4, 00:49:03, FastEthernet0/0

O 172.16.40.0/22 [110/2] via 10.10.10.2, 00:49:03, FastEthernet0/0

O 172.16.44.0/22 [110/66] via 10.10.10.2, 00:49:03, FastEthernet0/0

O 172.16.48.0/23 [110/66] via 10.10.10.4, 00:49:03, FastEthernet0/0

C 172.16.50.0/23 is directly connected, FastEthernet0/1

O 172.16.52.0/25 [110/2] via 10.10.10.4, 00:49:03, FastEthernet0/0

O 172.16.52.128/30 [110/65] via 10.10.10.2, 00:49:03, FastEthernet0/0

O 172.16.52.132/30 [110/65] via 10.10.10.4, 00:49:03, FastEthernet0/0

O*E2 0.0.0.0/0 [110/1] via 10.10.10.1, 00:49:03, FastEthernet0/0

R3#show ip ospf interface

FastEthernet0/0 is up, line protocol is up

Internet address is 10.10.10.3/29, Area 0

Process ID 1, Router ID 172.16.50.1, Network Type BROADCAST, Cost: 1
Transmit Delay is 1 sec, State DROTHER, Priority 100
Designated Router (ID) 172.16.52.130, Interface address 10.10.10.2
Backup Designated Router (ID) 172.16.52.133, Interface address 10.10.10.4
Timer intervals configured, Hello 10, Dead 40, Wait 40, Retransmit 5
Hello due in 00:00:03
Index 1/1, flood queue length 0
Next 0x0(0)/0x0(0)
Last flood scan length is 1, maximum is 1
Last flood scan time is 0 msec, maximum is 0 msec
Neighbor Count is 3, Adjacent neighbor count is 2
Adjacent with neighbor 172.16.52.130 (Designated Router)
Adjacent with neighbor 172.16.52.133 (Backup Designated Router)
Suppress hello for 0 neighbor(s)
FastEthernet0/1 is up, line protocol is up
Internet address is 172.16.50.1/23, Area 0
Process ID 1, Router ID 172.16.50.1, Network Type BROADCAST, Cost: 1
Transmit Delay is 1 sec, State DR, Priority 1
Designated Router (ID) 172.16.50.1, Interface address 172.16.50.1
No backup designated router on this network
Timer intervals configured, Hello 10, Dead 40, Wait 40, Retransmit 5
Hello due in 00:00:03

Index 2/2, flood queue length 0

Next 0x0(0)/0x0(0)

Last flood scan length is 1, maximum is 1

Last flood scan time is 0 msec, maximum is 0 msec

Neighbor Count is 0, Adjacent neighbor count is 0

Suppress hello for 0 neighbor(s)

R3#show ip ospf neighbor

Neighbor ID	Pri	State	Dead Time	Address	Interface
172.16.52.133	100	FULL/BDR	00:00:32	10.10.10.4	FastEthernet0/0
1.1.1.1	0	2WAY/DROTHER	00:00:32	10.10.10.1	FastEthernet0/0
172.16.52.130	255	FULL/DR	00:00:32	10.10.10.2	FastEthernet0/0

R3#show ip protocols

Routing Protocol is "ospf 1"

Outgoing update filter list for all interfaces is not set

Incoming update filter list for all interfaces is not set

Router ID 172.16.50.1

Number of areas in this router is 1. 1 normal 0 stub 0 nssa

Maximum path: 4

Routing for Networks:

10.10.10.0 0.0.0.7 area 0

172.16.50.0 0.0.1.255 area 0

Routing Information Sources:

Gateway	Distance	Last Update
1.1.1.1	110	00:20:02
172.16.50.1	110	00:20:11
172.16.52.129	110	00:20:45
172.16.52.130	110	00:20:11
172.16.52.133	110	00:20:02
172.16.52.134	110	00:20:46

Distance: (default is 110)

CONFIGURACION FINAL R4

R4#show running-config

Building configuration...

Current configuration : 1291 bytes

!

version 12.4

no service timestamps log datetime msec

no service timestamps debug datetime msec

no service password-encryption

!

hostname R4

!

```
enable secret 5 $1$mERr$hx5rVt7rPNoS4wqbXKX7m0
```

```
!
```

```
no ip domain-lookup
```

```
!
```

```
!
```

```
spanning-tree mode pvst
```

```
!
```

```
!
```

```
!
```

```
!
```

```
interface FastEthernet0/0
```

```
description interfaz de conexion con la red LAN R1, R2 y R3
```

```
ip address 10.10.10.4 255.255.255.248
```

```
ip ospf priority 100
```

```
duplex auto
```

```
speed auto
```

```
!
```

```
interface FastEthernet0/1
```

```
description interfaz de conexion con la red LAN R4
```

```
ip address 172.16.52.1 255.255.255.128
```

```
duplex auto
```

```
speed auto
```

```
interface Serial0/0/0
description interfaz de conexion con la red WAN R6
ip address 172.16.52.133 255.255.255.252
clock rate 56000
interface Serial0/0/1
no ip address
clock rate 2000000
shutdown
!
interface Vlan1
no ip address
shutdown
!
router ospf 1
log-adjacency-changes
network 10.10.10.0 0.0.0.7 area 0
network 172.16.52.132 0.0.0.3 area 0
network 172.16.52.0 0.0.0.127 area 0
!
ip classless
!
!
```

```
banner motd ^C
```

```
*****
```

```
* ! Solo Personal Autorizado, por favor digite su clave ! *
```

```
*****
```

```
^C
```

```
!
```

```
line con 0
```

```
password cisco
```

```
login
```

```
line vty 0 4
```

```
password cisco
```

```
login
```

```
!
```

```
!
```

```
!
```

```
end
```

R4#show ip route

Codes: C - connected, S - static, I - IGRP, R - RIP, M - mobile, B - BGP

D - EIGRP, EX - EIGRP external, O - OSPF, IA - OSPF inter area

N1 - OSPF NSSA external type 1, N2 - OSPF NSSA external type 2

E1 - OSPF external type 1, E2 - OSPF external type 2, E - EGP

i - IS-IS, L1 - IS-IS level-1, L2 - IS-IS level-2, ia - IS-IS inter area

* - candidate default, U - per-user static route, o - ODR

P - periodic downloaded static route

Gateway of last resort is 10.10.10.1 to network 0.0.0.0

10.0.0.0/29 is subnetted, 1 subnets

C 10.10.10.0 is directly connected, FastEthernet0/0

172.16.0.0/16 is variably subnetted, 9 subnets, 6 masks

O 172.16.0.0/19 [110/66] via 10.10.10.2, 00:53:59, FastEthernet0/0

O 172.16.32.0/21 [110/65] via 172.16.52.134, 00:54:59, Serial0/0/0

O 172.16.40.0/22 [110/2] via 10.10.10.2, 00:53:59, FastEthernet0/0

O 172.16.44.0/22 [110/66] via 10.10.10.2, 00:53:59, FastEthernet0/0

O 172.16.48.0/23 [110/65] via 172.16.52.134, 00:54:59, Serial0/0/0

O 172.16.50.0/23 [110/2] via 10.10.10.3, 00:53:59, FastEthernet0/0

C 172.16.52.0/25 is directly connected, FastEthernet0/1

O 172.16.52.128/30 [110/65] via 10.10.10.2, 00:53:59, FastEthernet0/0

C 172.16.52.132/30 is directly connected, Serial0/0/0

O*E2 0.0.0.0/0 [110/1] via 10.10.10.1, 00:53:59, FastEthernet0/0

R4#show ip protocols

Routing Protocol is "ospf 1"

Outgoing update filter list for all interfaces is not set

Incoming update filter list for all interfaces is not set

Router ID 172.16.52.133

Number of areas in this router is 1. 1 normal 0 stub 0 nssa

Maximum path: 4

Routing for Networks:

10.10.10.0 0.0.0.7 area 0

172.16.52.132 0.0.0.3 area 0

172.16.52.0 0.0.0.127 area 0

Routing Information Sources:

Gateway	Distance	Last Update
1.1.1.1	110	00:24:22
172.16.50.1	110	00:24:31
172.16.52.129	110	00:25:05
172.16.52.130	110	00:24:31
172.16.52.133	110	00:24:21
172.16.52.134	110	00:25:06

Distance: (default is 110)

R4#show ip ospf interface

FastEthernet0/0 is up, line protocol is up

Internet address is 10.10.10.4/29, Area 0

Process ID 1, Router ID 172.16.52.133, Network Type BROADCAST, Cost: 1

Transmit Delay is 1 sec, State BDR, Priority 100

Designated Router (ID) 172.16.52.130, Interface address 10.10.10.2

Backup Designated Router (ID) 172.16.52.133, Interface address 10.10.10.4

Timer intervals configured, Hello 10, Dead 40, Wait 40, Retransmit 5

Hello due in 00:00:07

Index 1/1, flood queue length 0

Next 0x0(0)/0x0(0)

Last flood scan length is 1, maximum is 1

Last flood scan time is 0 msec, maximum is 0 msec

Neighbor Count is 3, Adjacent neighbor count is 3

Adjacent with neighbor 1.1.1.1

Adjacent with neighbor 172.16.50.1

Adjacent with neighbor 172.16.52.130 (Designated Router)

Suppress hello for 0 neighbor(s)

FastEthernet0/1 is up, line protocol is up

Internet address is 172.16.52.1/25, Area 0

Process ID 1, Router ID 172.16.52.133, Network Type BROADCAST, Cost: 1

Transmit Delay is 1 sec, State DR, Priority 1

Designated Router (ID) 172.16.52.133, Interface address 172.16.52.1

No backup designated router on this network

Timer intervals configured, Hello 10, Dead 40, Wait 40, Retransmit 5

Hello due in 00:00:07

Index 2/2, flood queue length 0

Next 0x0(0)/0x0(0)

Last flood scan length is 1, maximum is 1

Last flood scan time is 0 msec, maximum is 0 msec

Neighbor Count is 0, Adjacent neighbor count is 0

Suppress hello for 0 neighbor(s)

Serial0/0/0 is up, line protocol is up

Internet address is 172.16.52.133/30, Area 0

Process ID 1, Router ID 172.16.52.133, Network Type POINT-TO-POINT, Cost: 64

Transmit Delay is 1 sec, State POINT-TO-POINT, Priority 0

No designated router on this network

No backup designated router on this network

Timer intervals configured, Hello 10, Dead 40, Wait 40, Retransmit 5

Hello due in 00:00:07

Index 3/3, flood queue length 0

Next 0x0(0)/0x0(0)

Last flood scan length is 1, maximum is 1

Last flood scan time is 0 msec, maximum is 0 msec

Neighbor Count is 1 , Adjacent neighbor count is 1

Adjacent with neighbor 172.16.52.134

Suppress hello for 0 neighbor(s)

R4#show ip ospf neighbor

Neighbor ID	Pri	State	Dead Time	Address	Interface
1.1.1.1	0	FULL/DROTHER	00:00:33	10.10.10.1	FastEthernet0/0
172.16.50.1	100	FULL/DROTHER	00:00:33	10.10.10.3	FastEthernet0/0
172.16.52.130	255	FULL/DR	00:00:33	10.10.10.2	FastEthernet0/0
172.16.52.134	0	FULL/ -	00:00:39	172.16.52.134	Serial0/0/0

CONFIGURACION FINAL R5

R5#show running-config

Building configuration...

Current configuration : 1242 bytes

!

version 12.4

no service timestamps log datetime msec

no service timestamps debug datetime msec

no service password-encryption

!

hostname R5

!

enable secret 5 \$1\$mERr\$hx5rVt7rPNoS4wqbXKX7m0

!

no ip domain-lookup

!

```
spanning-tree mode pvst
```

```
!
```

```
!
```

```
!
```

```
!
```

```
interface FastEthernet0/0
```

```
description Interfaz de conexion de la red LAN R5
```

```
ip address 172.16.44.1 255.255.252.0
```

```
duplex auto
```

```
speed auto
```

```
!
```

```
interface FastEthernet0/1
```

```
description Interfaz de conexion de la red LAN R5
```

```
ip address 172.16.0.1 255.255.224.0
```

```
duplex auto
```

```
speed auto
```

```
interface Serial0/0/0
```

```
description Interfaz de conexion de la red WAN R2
```

```
ip address 172.16.52.129 255.255.255.252
```

```
!
```

```
interface Serial0/0/1
```

```
no ip address
```

```
clock rate 2000000

shutdown

!

interface Vlan1

no ip address

shutdown

!

router ospf 1

log-adjacency-changes

network 172.16.52.128 0.0.0.3 area 0

network 172.16.44.0 0.0.3.255 area 0

network 172.16.0.0 0.0.31.255 area 0

!

ip classless

!

!

!

banner motd ^C

*****

* ! Solo personal autorizado, por favor digite su clave !

*****

^C
```

```
line con 0
password cisco
login
line vty 0 4
password cisco
login
!
!
!
end
```

R5#show ip route

Codes: C - connected, S - static, I - IGRP, R - RIP, M - mobile, B - BGP
D - EIGRP, EX - EIGRP external, O - OSPF, IA - OSPF inter area
N1 - OSPF NSSA external type 1, N2 - OSPF NSSA external type 2
E1 - OSPF external type 1, E2 - OSPF external type 2, E - EGP
i - IS-IS, L1 - IS-IS level-1, L2 - IS-IS level-2, ia - IS-IS inter area
* - candidate default, U - per-user static route, o - ODR
P - periodic downloaded static route

Gateway of last resort is 172.16.52.130 to network 0.0.0.0

10.0.0.0/29 is subnetted, 1 subnets

O 10.10.10.0 [110/65] via 172.16.52.130, 00:59:48, Serial0/0/0

172.16.0.0/16 is variably subnetted, 9 subnets, 6 masks

C 172.16.0.0/19 is directly connected, FastEthernet0/1

O 172.16.32.0/21 [110/130] via 172.16.52.130, 00:59:23, Serial0/0/0

O 172.16.40.0/22 [110/65] via 172.16.52.130, 01:00:23, Serial0/0/0

C 172.16.44.0/22 is directly connected, FastEthernet0/0

O 172.16.48.0/23 [110/130] via 172.16.52.130, 00:59:23, Serial0/0/0

O 172.16.50.0/23 [110/66] via 172.16.52.130, 00:59:38, Serial0/0/0

O 172.16.52.0/25 [110/66] via 172.16.52.130, 00:59:23, Serial0/0/0

C 172.16.52.128/30 is directly connected, Serial0/0/0

O 172.16.52.132/30 [110/129] via 172.16.52.130, 00:59:23, Serial0/0/0

O*E2 0.0.0.0/0 [110/1] via 172.16.52.130, 00:59:38, Serial0/0/0

R5#show ip protocols

Routing Protocol is "ospf 1"

Outgoing update filter list for all interfaces is not set

Incoming update filter list for all interfaces is not set

Router ID 172.16.52.129

Number of areas in this router is 1. 1 normal 0 stub 0 nssa

Maximum path: 4

Routing for Networks:

172.16.52.128 0.0.0.3 area 0

172.16.44.0 0.0.3.255 area 0

172.16.0.0 0.0.31.255 area 0

Routing Information Sources:

Gateway	Distance	Last Update
1.1.1.1	110	00:29:53
172.16.50.1	110	00:00:02
172.16.52.129	110	00:00:35
172.16.52.130	110	00:00:02
172.16.52.133	110	00:29:53
172.16.52.134	110	00:00:36

Distance: (default is 110)

R5#show ip ospf interface

FastEthernet0/1 is up, line protocol is up

Internet address is 172.16.0.1/19, Area 0

Process ID 1, Router ID 172.16.52.129, Network Type BROADCAST, Cost: 1

Transmit Delay is 1 sec, State DR, Priority 1

Designated Router (ID) 172.16.52.129, Interface address 172.16.0.1

No backup designated router on this network

Timer intervals configured, Hello 10, Dead 40, Wait 40, Retransmit 5

Hello due in 00:00:00

Index 1/1, flood queue length 0

Next 0x0(0)/0x0(0)

Last flood scan length is 1, maximum is 1

Last flood scan time is 0 msec, maximum is 0 msec

Neighbor Count is 0, Adjacent neighbor count is 0

Suppress hello for 0 neighbor(s)

FastEthernet0/0 is up, line protocol is up

Internet address is 172.16.44.1/22, Area 0

Process ID 1, Router ID 172.16.52.129, Network Type BROADCAST, Cost: 1

Transmit Delay is 1 sec, State DR, Priority 1

Designated Router (ID) 172.16.52.129, Interface address 172.16.44.1

No backup designated router on this network

Timer intervals configured, Hello 10, Dead 40, Wait 40, Retransmit 5

Hello due in 00:00:00

Index 2/2, flood queue length 0

Next 0x0(0)/0x0(0)

Last flood scan length is 1, maximum is 1

Last flood scan time is 0 msec, maximum is 0 msec

Neighbor Count is 0, Adjacent neighbor count is 0

Suppress hello for 0 neighbor(s)

Serial0/0/0 is up, line protocol is up

Internet address is 172.16.52.129/30, Area 0

Process ID 1, Router ID 172.16.52.129, Network Type POINT-TO-POINT, Cost: 64

Transmit Delay is 1 sec, State POINT-TO-POINT, Priority 0

No designated router on this network

No backup designated router on this network

Timer intervals configured, Hello 10, Dead 40, Wait 40, Retransmit 5

Hello due in 00:00:00

Index 3/3, flood queue length 0

Next 0x0(0)/0x0(0)

Last flood scan length is 1, maximum is 1

Last flood scan time is 0 msec, maximum is 0 msec

Neighbor Count is 1 , Adjacent neighbor count is 1

Adjacent with neighbor 172.16.52.130

Suppress hello for 0 neighbor(s)

R5#show ip ospf neighbor

Neighbor ID	Pri	State	Dead Time	Address	Interface
172.16.52.130	0	FULL/ -	00:00:32	172.16.52.130	Serial0/0/0

CONFIGURACION FINAL R6

R6#show running-config

Building configuration...

Current configuration : 1239 bytes

!

```
version 12.4

no service timestamps log datetime msec
no service timestamps debug datetime msec
no service password-encryption

!

hostname R6

!

!

!

enable secret 5 $1$mERr$hx5rVt7rPNoS4wqbXKX7m0

!

!

!

!

no ip domain-lookup

spanning-tree mode pvst

!

!

!

!

interface FastEthernet0/0

description Interfaz de conexion de la red LAN R6
```

```
ip address 172.16.48.1 255.255.254.0
```

```
duplex auto
```

```
speed auto
```

```
!
```

```
interface FastEthernet0/1
```

```
description Interfaz de conexion de la red LAN R6
```

```
ip address 172.16.32.1 255.255.248.0
```

```
duplex auto
```

```
speed auto
```

```
!
```

```
interface Serial0/0/0
```

```
description Interfaz de conexion de la red WAN R4
```

```
ip address 172.16.52.134 255.255.255.252
```

```
!
```

```
interface Serial0/0/1
```

```
no ip address
```

```
clock rate 2000000
```

```
shutdown
```

```
interface Vlan1
```

```
no ip address
```

```
shutdown
```

```
!
```

```
router ospf 1

log-adjacency-changes

network 172.16.52.132 0.0.0.3 area 0

network 172.16.32.0 0.0.7.255 area 0

network 172.16.48.0 0.0.1.255 area 0

!

ip classless

!

!

!

banner motd ^C

*****

* ! Solo Personal Autorizado, por favor digite su clave ! *

*****

^C

!

!

!

!

line con 0

password cisco

login
```

```
line vty 0 4
password cisco
login
!
!
end
```

R6#show ip route

Codes: C - connected, S - static, I - IGRP, R - RIP, M - mobile, B - BGP
D - EIGRP, EX - EIGRP external, O - OSPF, IA - OSPF inter area
N1 - OSPF NSSA external type 1, N2 - OSPF NSSA external type 2
E1 - OSPF external type 1, E2 - OSPF external type 2, E - EGP
i - IS-IS, L1 - IS-IS level-1, L2 - IS-IS level-2, ia - IS-IS inter area
* - candidate default, U - per-user static route, o - ODR
P - periodic downloaded static route

Gateway of last resort is 172.16.52.133 to network 0.0.0.0

```
10.0.0.0/29 is subnetted, 1 subnets
O    10.10.10.0 [110/65] via 172.16.52.133, 01:07:43, Serial0/0/0
172.16.0.0/16 is variably subnetted, 9 subnets, 6 masks
O    172.16.0.0/19 [110/130] via 172.16.52.133, 01:07:43, Serial0/0/0
```

C 172.16.32.0/21 is directly connected, FastEthernet0/1
O 172.16.40.0/22 [110/66] via 172.16.52.133, 01:07:43, Serial0/0/0
O 172.16.44.0/22 [110/130] via 172.16.52.133, 01:07:43, Serial0/0/0
C 172.16.48.0/23 is directly connected, FastEthernet0/0
O 172.16.50.0/23 [110/66] via 172.16.52.133, 01:07:43, Serial0/0/0
O 172.16.52.0/25 [110/65] via 172.16.52.133, 01:08:48, Serial0/0/0
O 172.16.52.128/30 [110/129] via 172.16.52.133, 01:07:43, Serial0/0/0
C 172.16.52.132/30 is directly connected, Serial0/0/0
O*E2 0.0.0.0/0 [110/1] via 172.16.52.133, 01:07:43, Serial0/0/0

R6#show ip protocols

Routing Protocol is "ospf 1"

Outgoing update filter list for all interfaces is not set

Incoming update filter list for all interfaces is not set

Router ID 172.16.52.134

Number of areas in this router is 1. 1 normal 0 stub 0 nssa

Maximum path: 4

Routing for Networks:

172.16.52.132 0.0.0.3 area 0

172.16.32.0 0.0.7.255 area 0

172.16.48.0 0.0.1.255 area 0

Routing Information Sources:

Gateway	Distance	Last Update
1.1.1.1	110	00:08:11
172.16.50.1	110	00:08:20
172.16.52.129	110	00:08:54
172.16.52.130	110	00:08:20
172.16.52.133	110	00:08:10
172.16.52.134	110	00:08:54

Distance: (default is 110)

R6#show ip ospf interface

FastEthernet0/1 is up, line protocol is up

Internet address is 172.16.32.1/21, Area 0

Process ID 1, Router ID 172.16.52.134, Network Type BROADCAST, Cost: 1

Transmit Delay is 1 sec, State DR, Priority 1

Designated Router (ID) 172.16.52.134, Interface address 172.16.32.1

No backup designated router on this network

Timer intervals configured, Hello 10, Dead 40, Wait 40, Retransmit 5

Hello due in 00:00:06

Index 1/1, flood queue length 0

Next 0x0(0)/0x0(0)

Last flood scan length is 1, maximum is 1

Last flood scan time is 0 msec, maximum is 0 msec

Neighbor Count is 0, Adjacent neighbor count is 0

Suppress hello for 0 neighbor(s)

FastEthernet0/0 is up, line protocol is up

Internet address is 172.16.48.1/23, Area 0

Process ID 1, Router ID 172.16.52.134, Network Type BROADCAST, Cost: 1

Transmit Delay is 1 sec, State DR, Priority 1

Designated Router (ID) 172.16.52.134, Interface address 172.16.48.1

No backup designated router on this network

Timer intervals configured, Hello 10, Dead 40, Wait 40, Retransmit 5

Hello due in 00:00:06

Index 2/2, flood queue length 0

Next 0x0(0)/0x0(0)

Last flood scan length is 1, maximum is 1

Last flood scan time is 0 msec, maximum is 0 msec

Neighbor Count is 0, Adjacent neighbor count is 0

Suppress hello for 0 neighbor(s)

Serial0/0/0 is up, line protocol is up

Internet address is 172.16.52.134/30, Area 0

Process ID 1, Router ID 172.16.52.134, Network Type POINT-TO-POINT, Cost: 64

Transmit Delay is 1 sec, State POINT-TO-POINT, Priority 0

No designated router on this network

No backup designated router on this network

Timer intervals configured, Hello 10, Dead 40, Wait 40, Retransmit 5

Hello due in 00:00:02

Index 3/3, flood queue length 0

Next 0x0(0)/0x0(0)

Last flood scan length is 1, maximum is 1

Last flood scan time is 0 msec, maximum is 0 msec

Neighbor Count is 1 , Adjacent neighbor count is 1

Adjacent with neighbor 172.16.52.133

Suppress hello for 0 neighbor(s)

R6#show ip ospf neighbor

Neighbor ID	Pri	State	Dead Time	Address	Interface
172.16.52.133	0	FULL/ -	00:00:39	172.16.52.133	Serial0/0/0

Tarea 7:

Entrega final del Informe

El informe a entregar debe contener los siguientes

elementos:

1. Portada
2. Justificación
3. Objetivos

4. Informe correspondiente al desarrollo del caso de estudio según las tareas establecidas en el transcurso del documento
5. Configuración final de cada uno de los dispositivos, describiéndose en detalle cada uno de los elementos que lo conforman. Por ejemplo, descripción de la configuración de interfaces, configuración del protocolo de enrutamiento, etc.
6. Conclusiones
7. Archivo de simulación en Packet Tracer

Se debe hacer entrega del trabajo en un archivo con el formato.zip

Nota. El trabajo correspondiente al caso de estudio es INDIVIDUAL, cualquier situación de copia o igualdad de trabajos desarrollados puede ser considerado motivo para anular el correspondiente trabajo y tendrá como nota final CERO (0.0)

CONCLUSIONES

Se realizó el diseño e implementación de la red Comerciantes S.A. de acuerdo a los datos suministrados por la empresa, dando conectividad a todos sus puntos.

Con la ayuda de la herramienta Packet Tracer se realizó virtualmente la configuración y puesta en marcha del diseño antes mencionado, aplicando las configuraciones, dispositivos y cableado necesario para lograr la conectividad entre los puntos de manera satisfactoria.

Prueba de ello se evidencia en las pruebas de conexión realizadas desde los host utilizados en la planificación del diseño de la red.

Los protocolos de enrutamiento de estado de enlace no son complejos y pueden comprenderse fácilmente, pueden configurarse con un comando y una sentencia de red, cada router aprende de sus propios enlaces y sus propias redes conectadas directamente enviando paquetes de saludo con otros routers; cada router utiliza la base de datos para construir un mapa completo de la topología y calcula el mejor camino hacia cada red de destino.

BIBLIOGRAFIA

Cisco Networking Academy. CCNA 1 EXPLORATION 4.0, Aspectos Básicos de Networking.

Cisco Networking Academy. CCNA 2 EXPLORATION 4.0, Conceptos y Protocolos de Enrutamiento.

CASO_DE_ESTUDIO_CCNA1.

CASO_DE_ESTUDIO_CCNA2.